

# Two-line Systems

## Product Catalogue



Productivity is key in today's global economy. Proper lubrication increases uptime and makes maintenance routines simple.



# Two-line Systems



## Our Experience

Lincoln was established in 1910 and is the long-standing world leader in grease lubrication systems and equipment. Decades of business experience have provided us with a high level of expertise and know-how within the lubrication system industry. As a pioneer in the industry, we will continue being a trend-setter confidently providing our customers with the best lubrication system solutions in both price and quality.



## Our Service

Our customer service includes the consulting, engineering and planning of customer-oriented systems for all applications, the manufacturing of standard components such as pumps, metering devices or control equipment, the installation and start up of lubrication systems on site in all parts of the world, as well as the customer training, and after-market service.

## Our Quality

Our certified Quality Management System according to DIN EN ISO 9001, our expertise, consulting qualities and inventiveness, lead the way for future customer-oriented, economical and intelligent solutions.



## Our Product

Lincoln lubrication systems reduce friction and wear; thereby, decreasing maintenance costs, improving productivity, ensuring a higher level of safety and contribution to the environment.

## Our Environmental Management System

Our Environmental Management System according to DIN EN ISO 14001 and EMAS, is an integral part of our company philosophy that reflects Lincoln's future orientation.

## Our Motto

Keep in motion –  
Bleiben Sie mit uns in Bewegung!

# Table of Contents

## Two-line Systems



<b>Schematic Two-line Systems</b>	<b>4 - 5</b>
-----------------------------------	--------------

Schematic



<b>Pumps</b>	<b>6 - 12</b>
--------------	---------------

HJ 2, ZPU, ZPU Accessories



<b>Two-line Metering Devices</b>	<b>13 - 19</b>
----------------------------------	----------------

VSG, VSL, VSKH, VSKV



<b>Change-over Valves</b>	<b>20 - 22</b>
---------------------------	----------------

DU 1, MP-2, EM-U2



<b>End-of-line Pressure Units</b>	<b>23</b>
-----------------------------------	-----------



<b>Index</b>	<b>24 - 26</b>
--------------	----------------

### Two-line Systems

Part Number	Page
223-13052-1	6/19
223-13052-2	6/19
223-13052-3	6/19
303-17505-1	19
303-17506-1	19
303-17507-1	19



# Two-line Systems



## Application

- Large systems with dispersed lube points
- Varying lubrication quantities
- Ideal for rigorous conditions (e.g. coldness)

Sample applications:

Large systems using grease up to NLGI 2

## Industries

Cement plants, steel mills, power plants, mining, large machines

The advantage of a two-line system is that it supplies an exact metered quantity of lubricant from one pumpstation over large distances.

The metering devices are operated by two main lines, whereby here the lubricant is simultaneously the control medium of the system.

The two-line system can be combined with secondary progressive metering devices, thereby increasing the total number of lubrication points that are served by a two-line metering device.

## Capabilities

- Lincoln's high pressure capability allows small diameter tubing to be used, thereby reducing installation and material costs. Additionally, this reduces the amount of grease in the tubing which over a long period of time may deteriorate.
- Visual or electric monitoring of each metering device outlet pair.
- If a bearing clogs or a metering device outlet fails to function, all other outlet pairs will continue to function normally.
- Simple and individual metering of lubricant.

- Problem-free readjustment of metered lubricant output after installation.
- Optimum monitoring and control possibility with a field bus system.
- Easy to extend.

## The Self-thinking System

The special components of a Lincoln self-thinking two-line system adjust the system to the optimum required pressure. Conventional two-line systems operate on a fixed pressure difference principle. This means that the change-over process is then initialized when a fixed pressure at the end of the lines has been reached.

Consequently, the system always operates at a maximum pressure.

With the Lincoln self-thinking two-line system, the pressure is constantly monitored and modified accordingly. The system thereby automatically regulates the pressure and can compensate for temperature fluctuations. Manual adjustments of the system, even during installation, are no longer required.

Since only the effective required pressure is generated during each lubrication cycle, the pump and other system components have a longer service life, the system always operates in its most efficient mode and the grease is subjected to less strain.

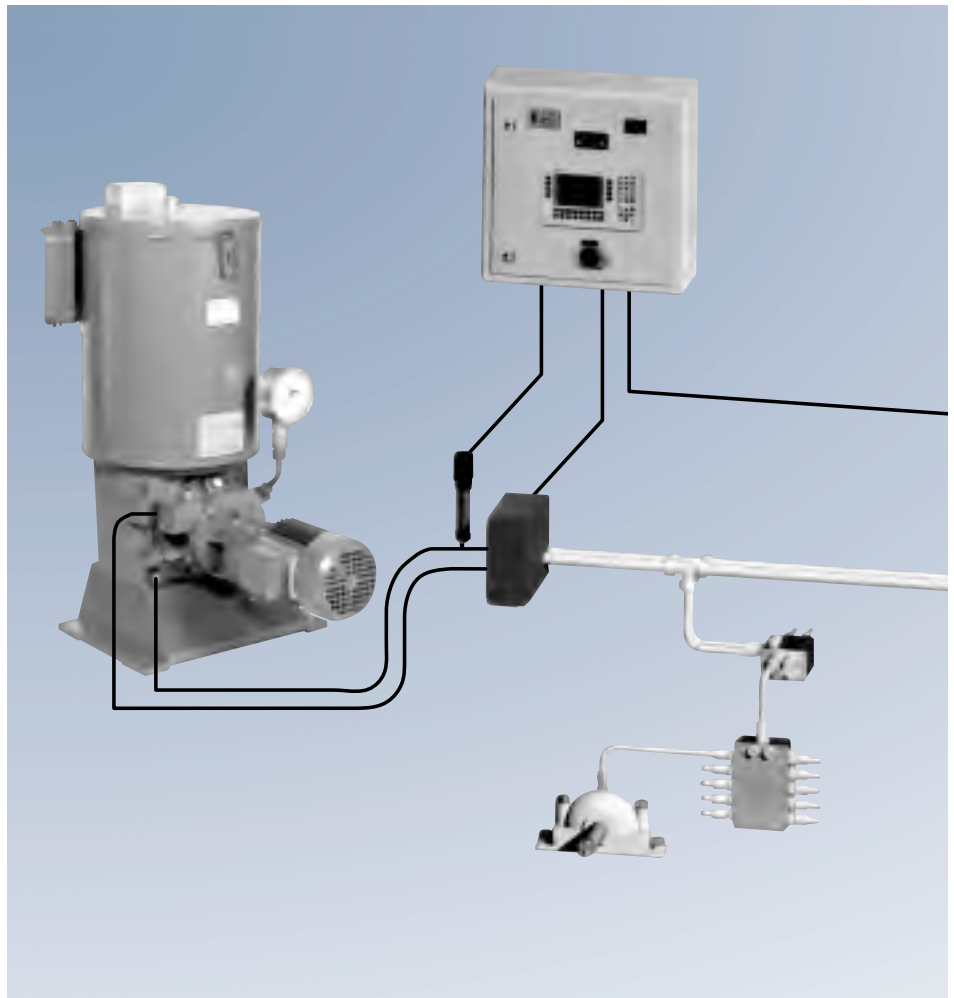

Schematic Two-line System

A further advantage is the direct display of all important parameters on the controller. This enables full monitoring of the system and the pump.

**Function of a Two-Line System**

In the first half-cycle, the lubricant is pumped into the main line (A) and the main line (B) is connected to the relief line. The lubricant, which is also the control medium for the system, is supplied to the metering devices. The pistons of the metering devices are moved into their adjusted end positions, thus dispensing an exact metered quantity of grease. Once all metering devices have dispensed their lubricant to the consumption point, the system is hydraulically

closed which causes the pressure in main line (A) to rise, and is measured by the pressure transducer. The control unit turns the pump off and signals the change-over valve to relieve main line (A).

At this point half of the lubrication points in the system have been lubricated. In the second half-cycle, main line (B) is pressurized and the cycle continues as before.

**Common Components**

pumps with reservoir:	HJ2 manual pumps, ZPU01/02, ZPU08/14/24 electric pumps
for drums:	PowerMaster pneumatic pumps*, Lubrigun pneumatic pumps
metering devices:	VSG, VSL, VSKH, VSKV
change-over valves:	DU1 pressure change-over valve EM-U2 electric change-over valve MP2 pneumatic change-over valve MHY1 hydraulic change-over valve

*\*Not covered in this catalogue – ask your Lincoln representative for details.*

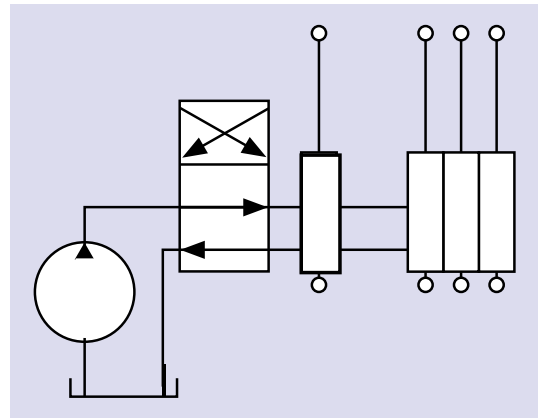

Schematic Two-line System



HJ2 Pump

The central lubrication pump type HJ (Helios Junior) is a manually operated high-pressure pump used for the supply of grease or oil in progressive systems, or when equipped with one pressure line and one relief line, for small two-line lubrication systems.

Part No.	Description
603-40558-3	HJ2L-30 left-hand lever 1 outlet
603-40558-4	HJ2R-30 right-hand lever 1 outlet
603-40558-1	HJ2AL-30 left-hand lever 2 outlets*
603-40558-2	HJ2AR-30 right-hand lever 2 outlets*

*\*for progressive systems*

## Technical Data

	HJ2	HJ2A
number of outlets	1	2
lubricant output per lever movement	2 cm <sup>3</sup> (0.122 in <sup>3</sup> )	2x1 cm <sup>3</sup> (2 X 0.061 in <sup>3</sup> )
operating pressure	300 bar (4350psi)	
hand force at maximum pressure	300 N	
suitable lubricants	grease up to NGLI 3	
outlet threaded connection	G 1/4 female (BSPP)	
reservoir capacity	3 liters (183 in <sup>3</sup> )	
weight empty	8.7 kg (19 lbs)	8.9 kg (19.6) lbs
dimensions (L x W x H)	410 x 140 x 393 mm (16.1 x 5.5 x 15.5 in)	

## Accessories

Part No.	Description
223-13052-1	check valve for 6 mm tube
223-13052-2	check valve for 8 mm tube
223-13052-3	check valve for 10 mm tube

# ZPU01/02 Pumps



Depending on the number of pump elements, these high-pressure, high-volume pumps can be used for following applications:

1. As a supply pump for small to mid size two-line systems ('F' version with filter block, safety valve and pressure gauge) in conjunction with a pressure-controlled change-over valve. The supply range lies within a radius of approximately 50 m from the pump depending on the ambient temperature and type of lubricant.
2. As a supply pump for progressive and single-line systems ('F' or 'V' version).

The principle of operation is similar to the very reliable and efficient multi-line pump 215. They are available with or without an ultrasonic level control and come with a 3-phase multi-range motor for 380 – 420 volt at 50 Hz or 440 – 480 volt at 60 Hz or with a free shaft end for use with other motors. Gear ratio is 100:1.



ZPU02 ... F

## Popular Models

Part No.	Description	Motor	Reservoir Size			Level Control	Pump Element
			Liters	In <sup>3</sup>	Lbs.		
661-40692-3	ZPU02-M100-010XYBU-F-380-420/440-480	3-phase	10	610	20	yes	bracket with 2 elements, filter block, pressure gauge and safety valve
661-40710-3	ZPU02-M100-030XYBU-F-380-420/440-480	3-phase	30	1830	60	yes	
661-40644-7	ZPU02-M100-010XN-F-000	none	10	610	20	no	
661-40710-7	ZPU01-M100-010-XYBU-E-380-420/440-480	3-phase	10	610	20	yes	1 element only

## Technical Data

<b>Number of Elements</b>	<b>1 or 2</b>
threaded connection:	
E version	G 1/4 female (BSPP)
V or F versions	for 10 mm tube or G 3/8 female (BSPP)
<b>filling connection</b>	G 3/8 female (BSPP)
<b>maximum operating pressure</b>	300 bar 4350 psi "E" version must be protected with pressure relief valve (not included)
<b>suitable lubricant</b>	grease up to NGLI 2 / NLGI 3 on request oil with a viscosity of min. 20 cSt
<b>lubricant output per pump element (output increases by 20% for 60 Hz applications)</b>	800 cm <sup>3</sup> / hour (49 in <sup>3</sup> / hour)
<b>reservoir sizes</b>	10 or 30 liter (2.6 or 8 U.S. gal)
<b>temperature range</b>	-20° to 70° C (-4° to 158° F)

## Required Pressure Relief Valve for Single Element "E" Version

Part No.	Description	Tube Diameter	Pressure
624-25478-1	relief valve	6 mm tube	200 bar (2900 psi)
624-25479-1	relief valve	6 mm tube	350 bar (5076 psi)
624-25480-1	relief valve	8 mm tube	200 bar (2900 psi)
624-25481-1	relief valve	8 mm tube	350 bar (5076 psi)
624-25482-1	relief valve	10 mm tube	200 bar (2900 psi)
624-28483-1	relief valve	10 mm tube	350 bar (5076 psi)

## Dimensions

Reservoir Size	Height	Width	Depth
10 liters (without low-level control)	514 mm (20.25 in)	379 mm (15 in)	317 mm (12.5 in)
30 liters (without low-level control)	754 mm (29.75 in)	431 mm (17 in)	377 mm (15 in)
low-level sensor	30 mm (1.2 in)	125 mm (5 in)	65 mm (2.75 in)



# Identification Code Models ZPU01/02



## Description

### Type Identification Code

Examples:

ZPU02 M 100 030 XYBU F 380-420/440-480

#### Basic Type of Central Lubrication Pump:

ZPU01 : pump with 1 element  
ZPU02 : pump with 2 elements

#### Drive Assemblies:

M : three-phase flanged motor  
motor designation with extension, e.g.  
for voltages frequencies, explosion-  
proof design is added to the pump  
type code.

100 : gear ratio = 1 : 100

#### Reservoir Assemblies:

010 : reservoir capacity 10 l  
030 : reservoir capacity 30 l

XY : reservoir for grease and oil  
N : reservoir without level monitoring  
BU : reservoir with low and high-level control  
(ultrasonic sensor)

*Note: The ultrasonic sensor is equipped with 2 switching points. If only one low-level control is desired, the corresponding contacts must be connected. A 24VDC supply voltage is required for the sensor.*

#### Pump Elements:

E : element(s)  
V : bracket with element(s) and pressure gauge  
F : bracket with element(s), filter block,  
pressure gauge and safety valve

#### Extension for Motor Designation:

380-420/440-480 : standard multi-range motor for 380-420V/50 Hz  
and 440-480 V/60 Hz  
000 : pump without motor, however with connecting flange

# ZPU08/14/24 Pumps



The high-pressure ZPU08, ZPU14 and ZPU24 pumps are primarily used in two-line systems or as a supply pump.

The pump element, made of hardened steel, operates as a piston pump with two pistons operating in opposite directions which draw in lubricant alternately and feed it through the outlet hole to the

pressure line. The outlet channels of the high-pressure pistons are controlled by a floating piston.

These state-of-the-art pumps are extremely serviceable and reliable. All main components are easily accessible. The pumps come standard with a pressure relief valve, a check valve, a lubricant filter, and a pressure gauge.



ZPU08-40XL

## Popular Models

Part No.	Description	Reservoir Size			Level Control	Motor
		Liters	In <sup>3</sup>	Lbs.		
605-40272-5	ZPU08G-40XL-380-415, 420-480	40	2441	80	yes	3-phase
605-40273-3	ZPU08G-100XB-380-415, 420-80	100	6102	200	yes	3-phase
605-40276-3	ZPU14G-100XB-380-415, 420-480	100	6102	200	yes	3-phase
605-40279-3	ZPU24G-100XB-380-415, 420-480	100	6102	200	yes	3-phase

## Technical Data

Model	ZPU08	ZPU14	ZPU24
lubricant output (output increases by 20% for 60 Hz applications)	8 liters/hour (2.1 U.S. gal/h) 488 in <sup>3</sup> /h	14 liters/hour (3.7 U.S. gal/h) 854 in <sup>3</sup> /h	24 liters/hour (6.3 U.S. gal/h) 1464 in <sup>3</sup> /h
drive speed	60 rpm	100 rpm	180 rpm
operating pressure	400 bar (5800 psi)		
connection thread	pressure line	G 3/4 female (BSPP)	
	relief line	G 3/4 female (BSPP)	
	filling line	G 3/4 female (BSPP)	
direction of rotation of the drive	optional		
reservoir capacity	40 or 100 liters/(10 or 26 U.S. gal) 2441 in <sup>3</sup> or 6102 in <sup>3</sup>		
lubricant filter	filter area 5.1 cm <sup>2</sup> grade of filtration 280 µm		
overpressure valve	fixed setting to 410 bar (5946 psi) tamper-proof		
operating temperature	-20° to 80 °C (-4° to 176 °F)		

## Dimensions

Reservoir Size	Height	Width	Depth
40 liters (without low-level control)	760 mm (30 in)	670–735 mm (26–29 in) depending on version	410 mm (16 in)
100 liters (without low-level control)	975 mm (38.5 in)	760–825 mm (30–32.5 in) depending on version	500 mm (20 in)

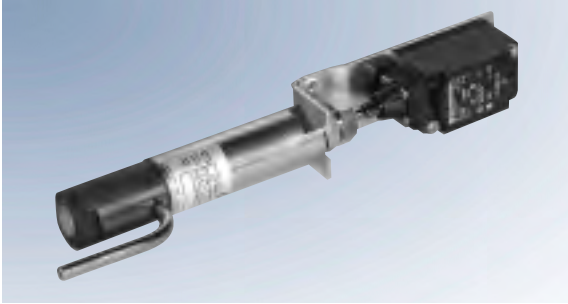

623-25461-2

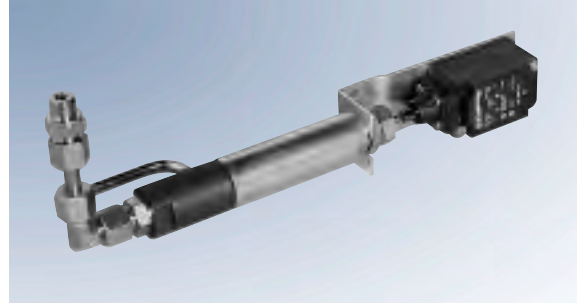

623-37243-1

## Accessories

Part No.	Description
623-25456-2	electric pressure switch 75 – 170 bar (1087 – 2465 psi)
623-25461-2	electric pressure switch 160 – 400 bar (2320 – 5800 psi)
623-37243-1	electric pressure switch kit for 40 l reservoir versions (includes part number 623-25461-2 and required connection fittings)
623-37242-1	electric pressure switch kit for 100 l reservoir versions (includes part number 623-25461-2 and required connection fittings)
623-37567-1	electronic pressure transducer kit for 40 and 100 l reservoir versions (includes electronic pressure switch with digital display, part number 234-13194-4, see accessories)



Electronic Pressure Transducer Kit  
623-37567-1

# Identification Code Pump Models ZPU08, ZPU14 & ZPU24



## Model Designation

The complete pump unit is defined by a model designation (mentioned on the nameplate).

Examples of model designations:

ZPU08	F	40	XL	000	
ZPU08	G	40	XN	380-415/420-480	C
ZPU14	G	100	XB	500	
ZPU14	S	40	XV	380-415/420-480	

### Lubricant Output:

08	= 8 dm <sup>3</sup> h <sup>-1</sup>
14	= 14 dm <sup>3</sup> h <sup>-1</sup>
24	= 24 dm <sup>3</sup> h <sup>-1</sup>

### Type of Drive:

F	: with free shaft end
G	: with flanged gear motor construction IMB5
S	: with worm gear and 3-phase motor construction IMV1
SF	: with worm gear and shaft end, suitable for 3-phase motor construction

S and SF only available for model 08

### Reservoir Capacity:

40	= 40 dm <sup>2</sup>
100	= 100 dm <sup>2</sup>

### Reservoir Design:

XN	= grease reservoir, standard design
XV	= grease reservoir with high-level control
XVD	= grease with high-level control and cover interlock switch
XL	= grease reservoir with low-level control
XB	= grease reservoir with high and low-level control

### Supply Voltage of the Motors:

380-415/420-480	= standard multi-range motor for 380-415/420-480V 50 Hz and 420-480V 60 Hz
500	= 500V, 50 Hz
000	= unit without motor
other voltages on request	

C	= version as feed pump for COBRA
---	----------------------------------

# VSG, VSL, VSKH and VSKV Two-line Metering Devices

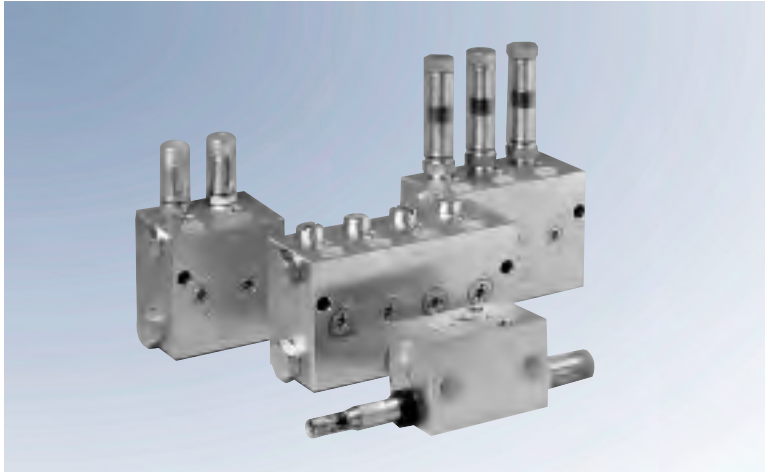

features include rust proof material, rust and acid proof material, electrical monitoring, adjusting device with magnetically operated function for rigorous environments, viton seals for high temperature applications, and NPT inlet/outlet threads. Refer to the identification code for model designations to order these devices with the additional features.

All models function on the same principle. The difference between VSL, VSG and VSKH lies in the output per outlet. Model VSKV has the same features as the VSKH with the exception that the outlet ports are located on the front face (vertical positioning). This provides an alternative for applications requiring a different tube orientation. Versions ...-MR (with magnetically operated indication of function) are designed without dynamic seals and can work under extremely adverse ambient conditions: water, dust, high temperature up to 120° C (176° F).

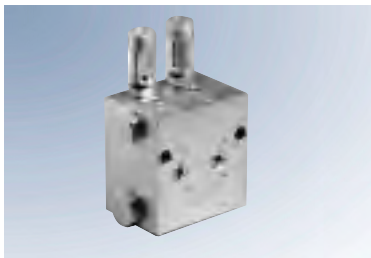

VSG-KR

These high quality, galvanized steel metering devices are designed for high-pressure (up to 400 bar) two-line systems. They can also be used in low to medium-pressure systems. They are available with up to 8 outlets. Each outlet pair is equipped with an indicator pin for visual monitoring. Additional optional

## VSG-KR Models

### VSG-KR

Indicator Pin and Adjustable Output 0–2.2 cm<sup>3</sup> (0–0.13 in<sup>3</sup>)

Connection Thread BSPP	Connection Thread BSPP	Number of Outlets	Connection Thread BSPP	Connection Thread NPTF	Connection Thread NPTF
Carbon Steel Galvanized	Stainless Steel (VA 1.4305/303)		Stainless Steel (VA 1.4571/316 Ti)	Carbon Steel Galvanized	Stainless Steel (VA 1.4305)
620-40022-1	620-40567-1	1		620-40022-2	
620-40015-1	620-40567-2	2	620-40839-2	620-40015-2	
620-40022-3	620-40567-3	3		620-40022-4	
620-40015-3	620-40567-4	4	620-40839-4	620-40015-4	
620-40022-5	620-40567-5	5		620-40022-6	
620-40015-5	620-40567-6	6	620-40839-6	620-40015-6	
620-40022-7	620-40567-7	7		620-40022-8	
620-40015-7	620-40567-8	8	620-40839-8	620-40015-8	



# VSG, VSL, VSKH and VSKV Two-line Metering Devices

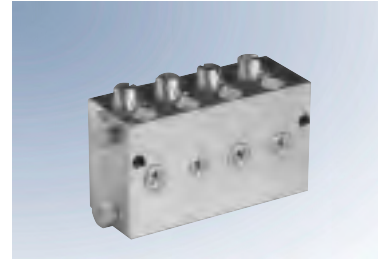

## VSG-KD and D

Indicator Pin and Fixed Output\* 2.2 cm<sup>3</sup> (0.13 in<sup>3</sup>) Metering Screw (KD) VSG8-D  
or with Metering Screw only (D) as Shown

KD		D		
Connection Thread BSPP		Number of Outlets	Connection Thread NPTF	
Carbon Steel Galvanized			Carbon Steel Galvanized	
620-40023-1	620-40025-1	1	620-40023-2	620-40025-2
620-40023-3	620-40025-3	2	620-40023-4	620-40025-4
620-40023-5	620-40025-5	3	620-40023-6	620-40025-6
620-40023-7	620-40025-7	4	620-40023-8	620-40025-8
620-40024-1	620-40026-1	5	620-40024-2	620-40026-2
620-40024-3	620-40026-3	6	620-40024-4	620-40026-4
620-40024-5	620-40026-5	7	620-40024-6	620-40026-6
620-40024-7	620-40026-7	8	620-40024-8	620-40026-8

\*also available: 0.55, 1.1, 1.65 cm<sup>3</sup> (0.0336, 0.067, 0.1 in<sup>3</sup>)

## VSG-KR-NP

Indicator Pin, Proximity Switch for Circular Plug M12 ( 237-13442-4)  
and Adjustable Output 0–2.2 cm<sup>3</sup> (0–0.13 in<sup>3</sup>)

Connection Thread BSPP	Number of Outlets	Connection Thread NPTF
Carbon Steel Galvanized		Carbon Steel Galvanized
620-40733-1	1	
620-40733-2	2	
620-40733-3	3	
620-40733-4	4	
620-40733-5	5	
620-40733-6	6	
620-40733-7	7	
620-40733-8	8	

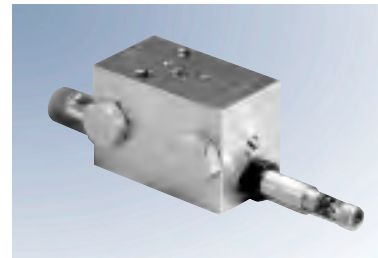

VSG2KR-NP

Note: High pressure-rated proximity switch is available as a retrofit for  
VSG models beyond series 9905. Part Number: 520-34018-1

# VSG, VSL, VSKH and VSKV Two-line Metering Devices



VSG6-MR

## VSG-MR Magnet Indicator Pin and Adjustable Output 0–2.2 cm<sup>3</sup> (0–0.13 in<sup>3</sup>)

Connection Thread BSPB	Number of Outlets	Connection Thread NPTF
Carbon Steel Galvanized		Carbon Steel Galvanized
620-40585-5	1	
620-40585-1	2	
620-40585-6	3	
620-40585-2	4	
620-40585-7	5	
620-40585-3	6	
620-40585-8	7	
620-40585-4	8	

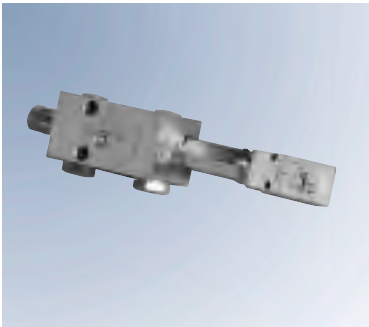

VSG2-KR-KS

## VSG-KR-KS Indicator Pin/Limit Switch Adjustable Output 0–2.2 cm<sup>3</sup> (0–0.13 in<sup>3</sup>)

Connection Thread BSPB	Number of Outlets	Connection Thread NPTF
Carbon Steel Galvanized		Carbon Steel Galvanized
620-40027-1	1	620-40027-2
620-40027-3	2	620-40027-4
620-40027-5	3	620-40027-6
620-40027-7	4	620-40027-8
620-40028-1	5	620-40028-2
620-40028-3	6	620-40028-4
620-40028-5	7	620-40028-6
620-40028-7	8	620-40028-8

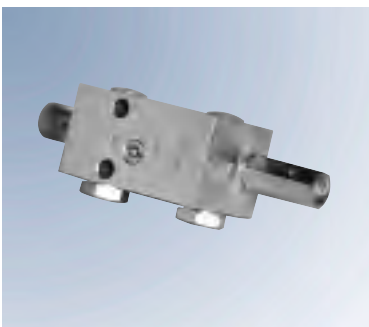

VSG2-KR-KA

## VSG-KR-KA Indicator Pin & Adapter for Proximity Switch (Thread M12 x 1) Adjustable Output 0–2.2 cm<sup>3</sup> (0–0.13 in<sup>3</sup>)

Connection Thread BSPB	Number of Outlets	Connection Thread NPTF
Carbon Steel Galvanized		Carbon Steel Galvanized
620-40605-1	2	
620-40605-2	4	
620-40605-3	6	
620-40605-4	8	

# VSG, VSL, VSKH and VSKV Two-line Metering Devices



## VSL-KR Indicator Pin and Adjustable Output 0–5 cm<sup>3</sup> (0–0.3 in<sup>3</sup>)

Connection Thread BSPP	Number of Outlets	Connection Thread NPTF
Carbon Steel Galvanized		Carbon Steel Galvanized
620-40062-1	1	620-40062-2
620-40062-3	2	620-40062-4
620-40062-5	3	620-40062-6
620-40062-7	4	620-40062-8
620-40064-1	5	610-40064-2
620-40064-3	6	620-40064-4
620-40064-5	7	620-40064-6
620-40064-7	8	620-40064-8



VSL4-KR

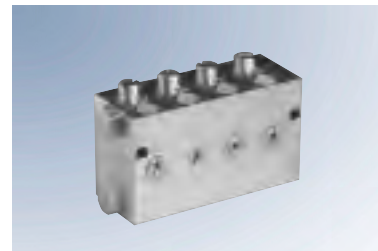

VSL8-D

## VSL-KD & D

Indicator Pin and Fixed Output\* 5.0 cm<sup>3</sup> (0.3 in<sup>3</sup>) Metering Screw (KD)  
or with Metering Screw only (D) as Shown

KD		Number of Outlets	D	
Connection Thread BSPP			Connection Thread NPTF	
Carbon Steel Galvanized			Carbon Steel Galvanized	
620-40065-1	620-40063-1	1	620-40065-2	620-40063-1
620-40065-3	620-40063-3	2	620-40065-4	620-40063-4
620-40065-5	620-40063-5	3	620-40065-6	620-40063-6
620-40065-7	620-40063-7	4	620-40065-6	620-40063-8
620-40066-1	620-40067-1	5	620-40066-2	620-40067-2
620-40066-3	620-40067-3	6	620-40066-4	620-40067-4
620-40066-5	620-40067-5	7	620-40066-6	620-40067-6
620-40066-7	620-40067-7	8	620-40066-8	620-40067-8

\*also available: 1.25, 2.5, 3.75 cm<sup>3</sup> (0.07, 0.15, 0.228 in<sup>3</sup>)

## VSL-KR-KA Indicator Pin & Adapter for Proximity Switch (Thread M12 x 1) Adjustable Output 0–5 cm<sup>3</sup> (0–0.3 in<sup>3</sup>)

Connection Thread BSPP	Number of Outlets	Connection Thread NPTF
Carbon Steel Galvanized		Carbon Steel Galvanized
620-40637-2	2	
620-40637-4	4	
620-40637-6	6	
620-40637-8	8	

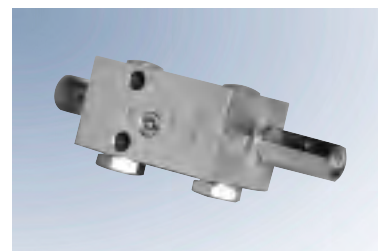

VSL2-KR-KA

# VSG, VSL, VSKH and VSKV Two-line Metering Devices



VSKV5-KR



VSKH5-KR

## VSKH-KR and VSKV-KR Indicator Pin & Adjustable Output 0–5 cm<sup>3</sup> (0–0.3 in<sup>3</sup>)

VSKH (Horizontal) Connection Thread BSPP			Number of Outlets	VSKV (Vertical) Connection Thread NPTF		
Carbon Steel Galvanized	303 Stainless Steel (VA 1.4305)	316Ti Stainless Steel (VA 1.4571)		Carbon Steel Galvanized	303 Stainless Steel (VA 1.4305)	316Ti Stainless Steel (VA 1.4571)
620-27438-1	620-27488-1	620-27766-1	1	620-27442-1	620-27496-1	620-27857-1
620-27418-1	620-27489-1	620-27767-1	2	620-27422-1	620-27497-1	620-27858-1
620-27439-1	620-27490-1	620-27768-1	3	620-27443-1	620-27498-1	620-27859-1
620-27419-1	620-27491-1	620-27769-1	4	620-27423-1	620-27499-1	620-27860-1
620-27440-1	620-27492-1	620-27770-1	5	620-27444-1	620-27500-1	620-27861-1
620-27420-1	620-27493-1	620-27771-1	6	620-27424-1	620-27501-1	620-27862-1
620-27441-1	620-27494-1	620-27772-1	7	620-27445-1	620-27502-1	620-27863-1
620-27421-1	620-27495-1	620-27773-1	8	620-27425-1	620-27503-1	620-27864-1

## Technical Data

Model	VSL	VSG	VSKH	VSKV
output per outlet and stroke (KR versions)	0–5.0 cm <sup>3</sup> (0–0.3 in <sup>3</sup> )	0–2.2 cm <sup>3</sup> (0–0.13 in <sup>3</sup> )	0–1.5 cm <sup>3</sup> (0–0.09 in <sup>3</sup> )	0–1.5 cm <sup>3</sup> (0–0.09 in <sup>3</sup> )
inlet thread	G3/8 (BSPP) 3/8 NPTF	G3/8 (BSPP) 3/8 NPTF	G1/4 (BSPP) 1/4 NPTF	G1/4 (BSPP) 1/4 NPTF
outlet thread	G1/4 (BSPP) 1/4 NPTF	G1/4 (BSPP) 1/4 NPTF	G1/4 (BSPP) 1/4 NPTF	G1/4 (BSPP) 1/4 NPTF
maximum operating pressure	400 bar (5800 psi)			
materials available	carbon steel galvanized			
	stainless steel: 1.4305 / 303			
	stainless steel: 14571 / 316 Ti			
maximum operating temperature	120° C (248° F) for MR and viton versions (KRFKM) 80° C (176° F) for standard versions (KR)			

## Dimensions for Standard KR Versions

Model	Height	Width	Depth
VSG-KR	122 mm (4.86 in)	2 outlet: 44.5 mm (1.78 in) 4 outlet: 76 mm (3.04 in)	54 mm (2.16 in)
VSL-KR	140 mm (5.6 in)	6 outlet: 108 mm (4.32 in) 8 outlet: 140 mm (5.6 in)	
VSKH-KR VSKV-KR	124 mm (4.96 in)	2 outlet: 52 mm (2.08 in) 4 outlet : 80 mm (3.2 in) 6 outlet: 108 mm (4.32 in) 8 outlet: 136 mm (5.44 in)	57 mm (2.28 in)

# Identification Code VSG, VSL, VSKH and VSKV Two-line Metering Devices



VSKV	6	VA	-KR	FKM	-KN			-01	(1.4571)
VSKV	2	VA	-KR						(1.4305)
VSG	4		-KR		-NP				
VSKV	5		-KR		-KS		C		
VSKV	8		-KR		-KN		TU	-A	
VSKH	4	VA			-KS		H		(1.4305)
VSKV	4		-D	0,6	-KS		H		
VSKH	2		-KR						(1.4305)

### Basic Types:

- VSKV = outlet vertical
- VSKH = outlet horizontal
- VSG/VSL = outlet horizontal

### Number of Outlets (max. 8):

### Standard Version

#### Steel Body Galvanized

- VA = stainless steel body

### Adjustment Device & Monitoring:

- KR = with indicator pin and infinitely variable adjustment device
- KRFKM = with indicator and infinitely variable adjustment device with viton seals (max. operating temp. 120 °C / 248 °F)
- MR = magnetic indicator and infinitely variable adjustment device
- KD = with indicator pin and metering screw
- D = with metering screw  
0.1; 0.3; 0.6; 0.9; 1.2; 1.5 cm<sup>3</sup>

### Adjustment Device Standard Version Galvanized:

- NP = piston detector
- KN = indicator pin and proximity switch
- KS = indicator pin and limit switch
- KA = indicator pin and adapter  
(proximity switch to be supplied by customer)

- BA = internal abbreviations
- TU = internal abbreviations
- H = internal abbreviations
- C = internal abbreviations

- 01, 02, 03 = two-digit number for special versions
- A = US-version (NPT - thread)

### Stainless Steel (Except VSL Models)

#### Material Number:

- 1.4305
- 1.4571 (acid resistant) for VSKH/VSKV/VSG only



# VSG, VSL, VSKH and VSKV Two-line Metering Devices



## Accessories

Part No.	Description
303-17526-2	closure plug for VSG/VSL
420-22139-1	outlet extension VSG (R1/4 x R1/4)
420-22140-1	outlet extension VSL (R1/4 x R1/4)
420-23628-1	outlet extension VSKH (R1/4 x R1/4)
420-23790-1	outlet extension VSKH (R1/4 x R1/4) stainless steel
303-17505-1	metering screw VSG 0.55 cm <sup>3</sup> (0.021 in <sup>3</sup> )
303-17506-1	metering screw VSG 1.10 cm <sup>3</sup> (0.043 in <sup>3</sup> )
303-17507-1	metering screw VSG 1.65 cm <sup>3</sup> (0.065 in <sup>3</sup> )
303-17508-1	metering screw VSG 2.2 cm <sup>3</sup> (0.087 in <sup>3</sup> )
303-17509-1	metering screw VSL 1.25 cm <sup>3</sup> (0.05 in <sup>3</sup> )
303-17510-1	metering screw VSL 2.50 cm <sup>3</sup> (0.099 in <sup>3</sup> )
303-17511-1	metering screw VSL 3.75 cm <sup>3</sup> (0.15 in <sup>3</sup> )
303-17512-1	metering screw VSL 5.00 cm <sup>3</sup> (0.196 in <sup>3</sup> )
223-13052-1	outlet check valve for 6 mm tube*
223-13052-2	outlet check valve for 8 mm tube*
223-13052-3	outlet check valve for 10 mm tube*
421-21288-1	mounting spacer ring 8.5 x 18 x 5

\* Outlet check valves are recommended when secondary progressive metering devices are used, or when the compression volume of the grease (about 2%) in the feed line to the lubrication point exceeds the output per outlet.

Welding mounting plates are available for all metering devices – ask your Lincoln representative for details.

# Change-over Valves DU1



DU1-GKS

Lincoln change-over valves come in pressure controlled, pneumatically operated, electric motor operated or hydraulically operated versions. They are primarily designed for use in two-line systems.

This pressure controlled change-over valve has a maximum operating pressure of 350 bar and is designed for use in two-line systems. The operating principle is similar to that of a 4/2 way valve which alternately discharges the lubricant fed by the pump into one of the two main lines while the other line is connected to the return line connection of the pump. Once a preset pressure is reached the change-over process is automatically initiated.

## It is Available in Three Models:

Part No.	Model	Description
617-28683-1	DU1-G	mounted on a base plate
617-28619-1	DU1-GK	mounted on a base plate with indicator pin
617-28620-1	DU1-GKS	mounted on a base plate with indicator pin and limit switch

## Technical Data

flow rate	maximum 14 liters/ hour (3.7 US gal/ hour)
operating pressure	maximum 350 bar (5075 psi)
change over pressure	minimum 140 bar (2030 psi) maximum 350 bar (5075 psi)
factory setting	170 bar (2465 psi)
threaded connections	G 1/2 female (BSPP)
operating temperature	-20° C to 80° C (-4° F to 176° F)
mounting position	variable
position switch	max.
nominal circuit voltage	500 V, 25–60 Hz
continuous current	10 A
operating current	4A

## Dimensions

Model	Height	Width	Depth
DU1-GK	195 mm (7.8 in)	190 mm (7.6 in)	100 mm (4.0 in)
617-28619-1			
DU1-GKS	195 mm (7.8 in)	190 mm (7.6 in)	195 mm (7.8 in)
619-28620-1			

# Change-over Valves MP2



This pneumatically operated change-over valve is designed for use in two-line systems and operates like a 4/2 way valve which alternately discharges the lubricant fed by the pump into one of both main lines, while the other main line is connected to the return line connection of the pump. It can also be used as a 3/2 way valve for grease systems.

It is available in four voltages, 24 VDC, 110 VAC, 110 VDC and 220 VAC.

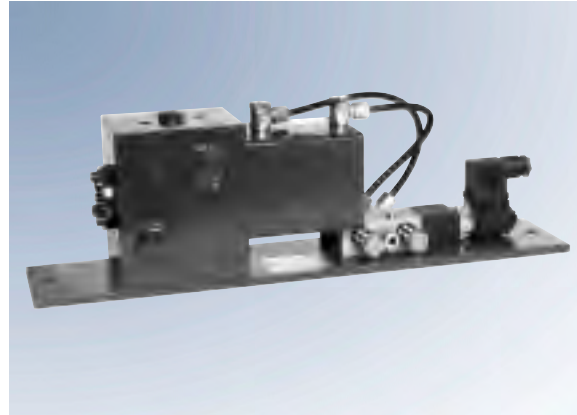

MP2

## Models

Part No.	Supply Voltage	Description
618-28965-2	24 VDC	MP2-24VDC
618-28964-2	110 V, 50/60 Hz	MP2-110AC/50-60Hz
618-28963-1	110 DC	MP2-110VDC
618-28966-2	220V, 50/60 Hz	MP2-220AC

## Technical Data

flow rate	maximum 65 liters/hour (17 US gal/hour)
operating pressure	400 bar (5800 psi)
compressed air	max. 10 bar (145 psi)
threaded connections	G 3/4 female (BSPP)
operating temperature	-20° C to 70° C (-4° F to 158° F)
mounting position	variable
sound pressure level	< 70 dBA

## Dimensions

	Height	Width	Depth
MP2	135 mm (5.4 in)	400 mm (16 in)	180 mm (7.2 in)

## Also Available Hydraulically Operated: Model MHY1

Part No.	Supply Voltage	Description
618-28883-2	24 VDC	MHY1-24VDC

Technical data correspond to MP2.

Operating hydraulic pressure: max. 60 bar (870 psi)

# Change-over Valves EM-U2



EM-U2

This electric motor operated change over valve is designed for use in two-line systems with a maximum operating pressure of 400 bar. It is available in 24 VDC and 230 VAC versions.

The principal of operation is similar to that of a 4/2 way valve which alternately discharges the lubricant fed by the pump into one of the two main lines while

the other line is connected to the return line connection of the pump. After all metering devices in the system have completed a half-cycle, the signaled change over process commences.

Depending on the version, the EM-U2 can also be used as a 2/2 or 3/2 way slider valve for lubrication circuits.

## Models

Part Nos.		Description
24 VDC Version	230 VAC Version	
618-28387-1	618-28388-1	change-over valve 4/2 way
625-28448-1	625-28450-1	3/2 way valve connection B closed
625-28449-1	625-28451-1	3/2 way valve connection R closed
625-28590-1	625-28591-1	2/2 way valve connections B & R closed

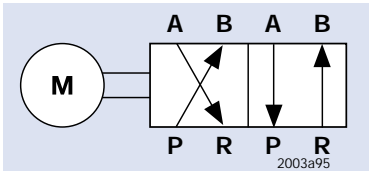

Change-over Valve  
(4/2 Way Valve)

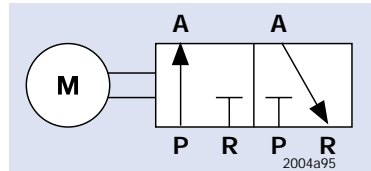

3/2 Way Valve  
Connection B Closed

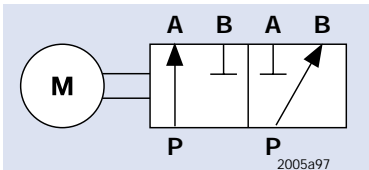

3/2 Way Valve  
Connection R Closed

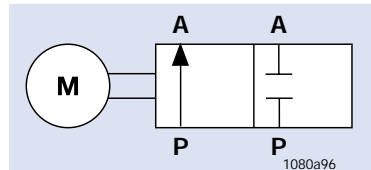

3/2 Way Valve  
Connection B + R Closed

## Technical Data

flow rate	maximum 65 liters/hour (17 US gal/hour)
operating pressure	maximum 400 bar (5800 psi)
threaded connections	G3/4 female (BSPP)
operating temperatures	-20° C to 80° C (-4° F to 176° F)
mounting position	variable
sound level	< 70 dBA
switching time	0.5 seconds
supply voltage	24 VDC or 230 VAC

## Dimensions

	Height	Width	Depth
EM-U2	210 mm (8.4 in)	350 mm (14.0 in)	160 mm (8.3 in)

# End-of-line Pressure Unit



End-of-line Pressure Unit 632-36501-1

The conventional end-of-line pressure unit is used for the control and monitoring of two-line systems.

<b>Part No.:</b>	632-36501-1
<b>Dimensions:</b>	400 mm high x 300 wide
<b>Consists of:</b>	electric/hydraulic pressure switch with limit switch, two pressure gauges 0–600 bar and connection fittings for 10 mm tube
<b>Connection:</b>	for 10 mm tube or G3/8 female (BSPP)



Electronic Pressure Unit 632-36627-1

Electronic end-of-line pressure unit for the control and monitoring of two-line systems

<b>Part No.:</b>	632-36627-1
<b>Dimensions:</b>	275 mm high x 150 wide (10.8 x 5.9 in)
<b>Consists of:</b>	two electronic pressure switches with digital display
<b>Connection:</b>	fittings for 12 mm tube



# Index

## Two-line Systems



Part No.	Page	Part No.	Page	Part No.	Page
223-13052-1	6/19	618-28964-2	21	620-27501-1	17
223-13052-2	6/19	618-28965-2	21	620-27502-1	17
223-13052-3	6/19	618-28966-2	21	620-27503-1	17
303-17505-1	19	620-27418-1	17	620-27766-1	17
303-17506-1	19	620-27419-1	17	620-27767-1	17
303-17507-1	19	620-27420-1	17	620-27768-1	17
303-17508-1	19	620-27421-1	17	620-27769-1	17
303-17509-1	19	620-27422-1	17	620-27770-1	17
303-17510-1	19	620-27423-1	17	620-27771-1	17
303-17511-1	19	620-27424-1	17	620-27772-1	17
303-17512-1	19	620-27425-1	17	620-27773-1	17
303-17526-2	19	620-27438-1	17	620-27857-1	17
420-22139-1	19	620-27439-1	17	620-27858-1	17
420-22140-1	19	620-27440-1	17	620-27859-1	17
420-23628-1	19	620-27441-1	17	620-27860-1	17
420-23790-1	19	620-27442-1	17	620-27861-1	17
421-21288-1	19	620-27443-1	17	620-27862-1	17
603-40558-1	6	620-27444-1	17	620-27863-1	17
603-40558-2	6	620-27445-1	17	620-27864-1	17
603-40558-3	6	620-27488-1	17	620-40015-1	13
603-40558-4	6	620-27489-1	17	620-40015-2	13
605-40272-5	10	620-27490-1	17	620-40015-3	13
605-40273-3	10	620-27491-1	17	620-40015-4	13
605-40276-3	10	620-27492-1	17	620-40015-5	13
605-40279-3	10	620-27493-1	17	620-40015-6	13
617-28619-1	20	620-27494-1	17	620-40015-7	13
617-28620-1	20	620-27495-1	17	620-40015-8	13
617-28683-1	20	620-27496-1	17	620-40022-1	13
618-28387-1	22	620-27497-1	17	620-40022-2	13
618-28388-1	22	620-27498-1	17	620-40022-3	13
618-28883-2	21	620-27499-1	17	620-40022-4	13
618-28963-1	21	620-27500-1	17	620-40022-5	13

# Index

## Two-line Systems



Part No.	Page	Part No.	Page	Part No.	Page
620-40022-6	13	620-40026-6	14	620-40063-6	16
620-40022-7	13	620-40026-7	14	620-40063-7	16
620-40022-8	13	620-40026-8	14	620-40063-8	16
620-40023-1	14	620-40027-1	15	620-40064-1	16
620-40023-2	14/16	620-40027-2	15	620-40064-2	16
620-40023-3	14	620-40027-3	15	620-40064-3	16
620-40023-4	14	620-40027-4	15	620-40064-4	16
620-40023-5	14	620-40027-5	15	620-40064-5	16
620-40023-6	14/16	620-40027-6	15	620-40064-6	16
620-40023-7	14	620-40027-7	15	620-40064-7	16
620-40023-8	16	620-40027-8	15	620-40064-8	16
620-40024-1	14	620-40028-1	15	620-40065-1	16
620-40024-2	14/16	620-40028-2	15	620-40065-2	16
620-40024-3	14	620-40028-3	15	620-40065-3	16
620-40024-4	14/16	620-40028-4	15	620-40065-4	16
620-40024-5	14	620-40028-5	15	620-40065-5	16
620-40024-6	14/16	620-40028-6	15	620-40065-6	16
620-40024-7	14	620-40028-7	15	620-40065-7	16
620-40024-8	14/16	620-40028-8	15	620-40065-8	16
620-40025-1	14	620-40062-1	16	620-40066-1	16
620-40025-2	14	620-40062-2	16	620-40066-2	16
620-40025-3	14	620-40062-3	16	620-40066-3	16
620-40025-4	14	620-40062-4	16	620-40066-4	16
620-40025-5	14	620-40062-5	16	620-40066-5	16
620-40025-6	14	620-40062-6	16	620-40066-6	16
620-40025-7	14	620-40062-7	16	620-40066-7	16
620-40025-8	14	620-40062-8	16	620-40066-8	16
620-40026-1	14	620-40063-1	16	620-40067-1	16
620-40026-2	14	620-40063-2	16	620-40067-2	16
620-40026-3	14	620-40063-3	16	620-40067-3	16
620-40026-4	14	620-40063-4	16	620-40067-4	16
620-40026-5	14	620-40063-5	16	620-40067-5	16

# Index

## Two-line Systems



Part No.	Page	Part No.	Page
620-40067-6	16	620-40733-6	14
620-40067-7	16	620-40733-7	14
620-40067-8	16	620-40733-8	14
620-40567-1	13	620-40839-2	13
620-40567-2	13	620-40839-4	13
620-40567-3	13	620-40839-6	13
620-40567-4	13	620-40839-8	13
620-40567-5	13	623-25456-2	11
620-40567-6	13	623-25461-2	11
620-40567-7	13	623-37242-1	11
620-40567-8	13	623-37243-1	11
620-40585-1	15	623-37567-1	11
620-40585-2	15	624-25478-1	8
620-40585-3	15	624-25479-1	8
620-40585-4	15	624-25480-1	8
620-40585-5	15	624-25481-1	8
620-40585-6	15	624-25482-1	8
620-40585-7	15	624-28483-1	8
620-40585-8	15	625-28448-1	22
620-40605-1	15	625-28449-1	22
620-40605-2	15	625-28450-1	22
620-40605-3	15	625-28451-1	22
620-40605-4	15	625-28590-1	22
620-40637-2	16	625-28591-1	22
620-40637-4	16	632-36501-1	23
620-40637-6	16	661-40644-7	7
620-40637-8	16	661-40692-3	7
620-40733-1	14	661-40710-3	7
620-40733-2	14	661-40710-7	7
620-40733-3	14		
620-40733-4	14		
620-40733-5	14		

Productivity is key in today's global economy. Lincoln – the leader in knowledge, technology and service for lubrication systems – is key to your Total Productivity Maintenance System.

Now you got our catalogue about "Two-line Systems". Other Lincoln catalogues, brochures, owner manuals and technical information are available at your local Lincoln office, distributor or sales agency, or at Lincoln GmbH & Co. KG, Walldorf, Germany (see address on last page).

For more information just get in touch – phone, fax, or click: [www.lincolnindustrial.com/Locator/Distributor](http://www.lincolnindustrial.com/Locator/Distributor) to find your nearest Lincoln representative.

**You know: Information is key to your productivity.**



# Lincoln's Global Distribution Network Is the Best in the Industry



In all levels of service – lubrication system evaluation, custom-engineered system installation, or the supply of top-quality products – your Lincoln distributor makes certain you always get the very best value.

#### **Systems House Distributors**

Our systems house distributors offer the highest level of expertise available in the industry. They custom-design systems with the exact combination of Lincoln components you need. Then they install the system in your plant with experienced technicians or work with your personnel to make sure the job is done correctly. Each distributor stocks a full inventory of pumps, metering devices, controllers, monitors and accessories. Each continues to meet our stringent requirements for product, systems and service knowledge. From St. Louis to Singapore, Walldorf and worldwide, Lincoln's top-of-the-industry systems house distributors will be there when and where you need them.

**For the nearest authorized Lincoln sales and service representative, call:**

#### **Americas:**

St. Louis, Missouri  
Phone +1 314.679.4200  
Fax: +1 800.424.5359

#### **Europe/Middle East/Africa:**

Walldorf, Germany  
Phone + 49.6227.33.0  
Fax: + 49.6227.33.259

#### **Asia/Pacific:**

Singapore  
Phone + 65.65627960  
Fax: + 65.65629967



Heinrich-Hertz-Str. 2-8  
D-69190 Walldorf  
Germany

Phone + 49.6227.33.0  
Fax + 49.6227.33.259  
[www.lincolnindustrial.de](http://www.lincolnindustrial.de)  
[lincoln@lincolnindustrial.de](mailto:lincoln@lincolnindustrial.de)

Form W-112-A-0103  
© Copyright 2003  
Printed in Germany

