

lubrication systems



ILCOMATIC 3

VOLUMETRIC METERING VALVES

FOR OIL AND SOFT GREASE OPERATION

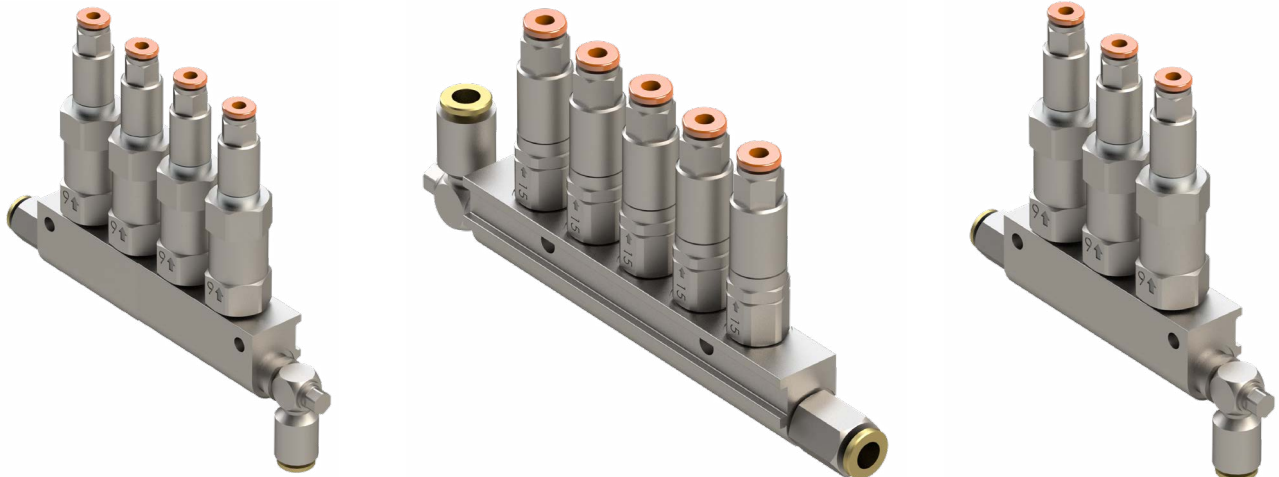

General information	3
Operation	4
System structure	5
Valves for Distributor	6
Dimensions of valves for Distributor	7
Valves for Point	8
Swivel terminals	9
Distributors	10
One-sided distributors	12
Piston metering valves	13
Fittings	14



All ILC products must only be used for their intended purposes, as specified in this brochure and in all instructions. If the product is supplied together with user instructions, the user is required to read them and comply with them. Not all lubricants are suitable for centralised lubrication systems. ILC lubrication systems or relative components cannot be used together with gas, liquid gas, pressurised gas in solution and liquids with vapour pressure exceeding normal atmospheric pressure (1013 bar) by more than 0.5 bar, maximum temperature permitted. Any type of dangerous materials, namely those classified as such by European Community Directive (EC) 67/548/EEC, Article 2 (2), can only be used in ILC centralised lubrication systems or relative components upon consultation with ILC and after having received written approval from the company.

Technical data

Lubricants	Oil 32 cSt – 2000 cSt	
	Soft greases NLGI 000-00	
Temperature	from 0 °C to 80 °C	
Seals	NBR	
	VITON (on request)	
Work pressure	From 12 bar to 50 bar	for flow rates 15-30-60-100-160-500-750-1000 mm ³
	From 15 to 50 bar	for flow rates 200-300 mm ³
Maximum release pressure	2.5 bar	flow rates 15-30-60-100-160 mm ³
	2 bar	for flow rates 200-300 mm ³
	2 bar	flow rates 500-750-1000 mm ³
Minimum pause time	15"	for Oils from 32 to 250 cSt
	200"	for Oils from 260 to 2000 cSt and nlgi 00 soft greases

Important: the data provided above are theoretical and subject to variation based on the extension of the system, the size of the main pipe, the type of lubricant used and the working temperature.

General information

The ilcomatic 3 metering valves are used in centralised lubrication systems operating with oil or soft grease. They can be installed on one-sided or two-sided aluminium distributors or directly on the point to be lubricated. For correct operation, the line pressure must not be less than 15 bar with a very slow delivery thrust.

The lubricant is delivered by a pump in order to achieve the pressure required. The valves are set up for a later delivery of lubricant when the pump stops and consequently when the pressure is released in the main lines. They can be used in medium and large plants with a high number of points.

Main Applications: machine tools, woodworking machines, textile machines, packaging machines, machines for plastics, machines for glass, printing machines and in general when a precise amount of lubricant needs to be provided.

Operation

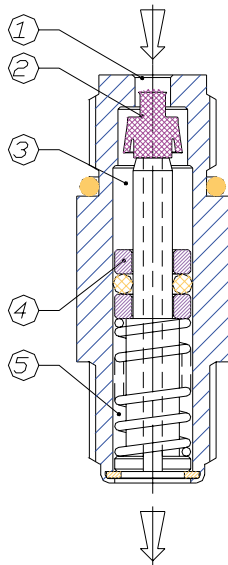

By Operating The Pump, The Pressure Arrives at The Hole (1) And, Through The Tightening of The Valve Lip (2) The Lubricant Enters The Chamber (3) Consequently Moving The Piston (4) Which Supplies The Flow Rate Previously Accumulated In The Chamber (5).

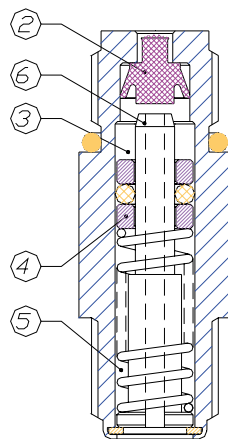

During The Release Stage The Piston (4), Pushed By The Spring, Returns To The Initial Position. Its Movement Removes The Seal Valve (2), Opens The Hole (6) And The Lubricant Is Transferred From The Chamber (3) To (5).

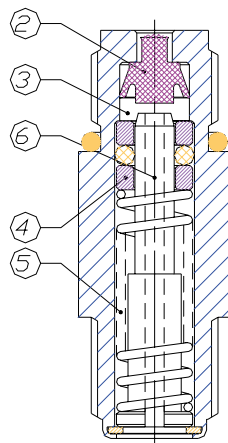

The Piston (4) Has Completed Its Stroke. The Lubricant Has Fully Transferred From Chamber (3) To (5). The Seal Valve (2) Has Closed The Hole (6). The Metering Valve Is Ready For A New Cycle.

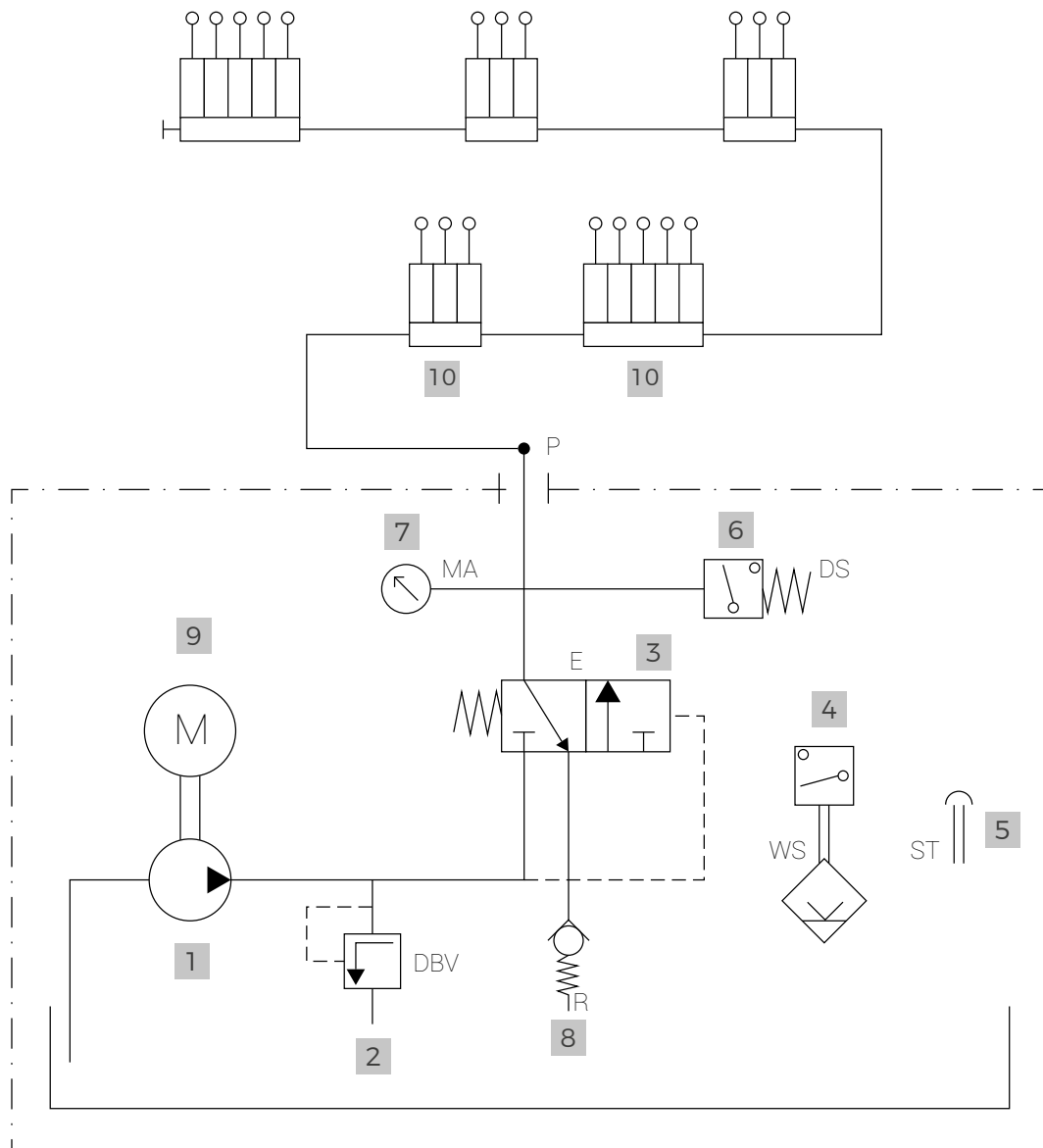

- | | | | |
|---|----------------------------------|----|--------------------------------------|
| 1 | gear pump (CME or MPT) | 6 | oil pressure control pressure switch |
| 2 | pressure relief valve | 7 | pressure gauge |
| 3 | release valve | 8 | intake valve |
| 4 | minimum level of lubricant check | 9 | electric motor |
| 5 | lubricant loading filter | 10 | metering valves |

M10x1 (M) - M10x1 (M)



Code	Flow rate	Mark
02.709.0	15 mm ³	15
02.709.1	30 mm ³	30
02.709.2	60 mm ³	60
02.709.3	100 mm ³	100
02.709.4	160 mm ³	160
02.709.5	200 mm ³	200
02.709.6	300 mm ³	300



Code	Flow rate	Mark
02.601.6	500 mm ³	6
02.601.7	750 mm ³	7
02.601.8	1000 mm ³	8

M10x1 (M) - PUSH IN



Code	Flow rate	Mark
02.710.0	15 mm ³	15
02.710.1	30 mm ³	30
02.710.2	60 mm ³	60
02.710.3	100 mm ³	100
02.710.4	160 mm ³	160
02.710.5	200 mm ³	200
02.710.6	300 mm ³	300



Code	Flow rate	Mark
02.710.7	500 mm ³	6
02.710.8	750 mm ³	7
02.710.9	1000 mm ³	8

M10x1 (M) - M8x1 (F)



Code	Flow rate	Mark
02.713.0	15 mm ³	15
02.713.1	30 mm ³	30
02.713.2	60 mm ³	60
02.713.3	100 mm ³	100
02.713.4	160 mm ³	160
02.713.5	200 mm ³	200
02.713.6	300 mm ³	300

M1/8" (M) - M10x1 (M)



Code	Flow rate	Mark
02.739.0	15 mm ³	15
02.739.1	30 mm ³	30
02.739.2	60 mm ³	60
02.739.3	100 mm ³	100
02.739.4	160 mm ³	160
02.739.5	200 mm ³	200
02.739.6	300 mm ³	300

1/8" (M) - PUSH IN



Code	Flow rate	Mark
02.742.0	15 mm ³	15
02.742.1	30 mm ³	30
02.742.2	60 mm ³	60
02.742.3	100 mm ³	100
02.742.4	160 mm ³	160
02.742.5	200 mm ³	200
02.742.6	300 mm ³	300

1/8" (M) - 5/16" (M)



Code	Flow rate	Mark
02.737.0	15 mm ³	15
02.737.1	30 mm ³	30
02.737.2	60 mm ³	60
02.737.3	100 mm ³	100
02.737.4	160 mm ³	160
02.737.5	200 mm ³	200
02.737.6	300 mm ³	300

The seals are NBR. On request, valves with Viton seals are available, add the letter "V" to the code, e.g. 02.709.0.V

M10x1 (M) - M10x1 (M)

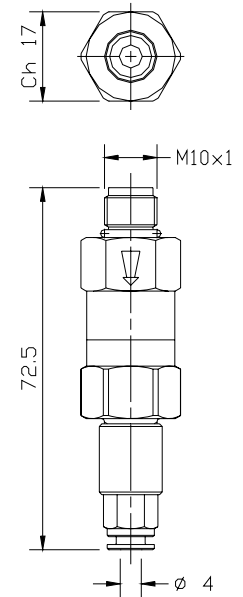
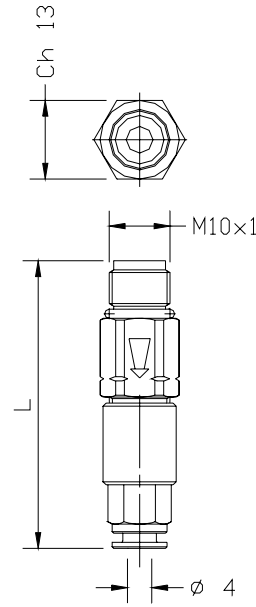
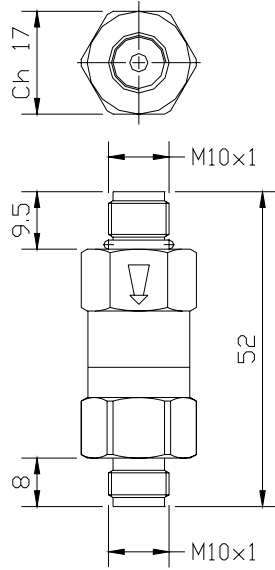
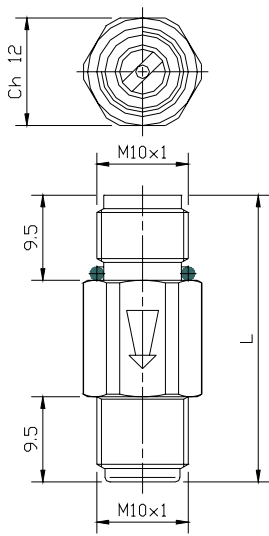

Code	L	Code	L	Code	L	Code	L
02.709.0/4	32 mm	02.601.6/8	52 mm	02.710.0/4	51 mm	02.710.6/8	72.5 mm
02.709.5/6	37.6 mm			02.710.5/6	56.5 mm		

M10x1 (M) - M8x1 (F)

1/8" (M) - PUSH IN

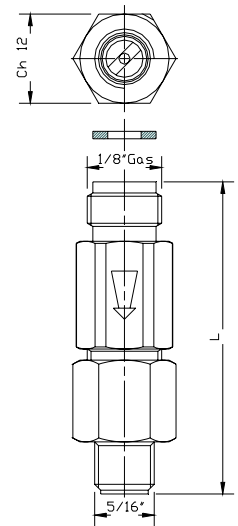
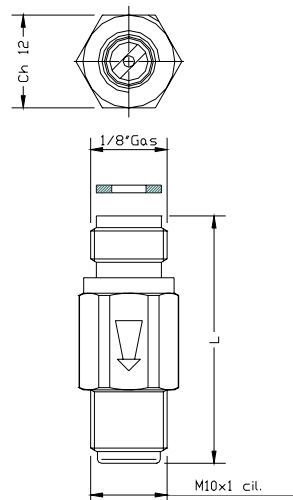
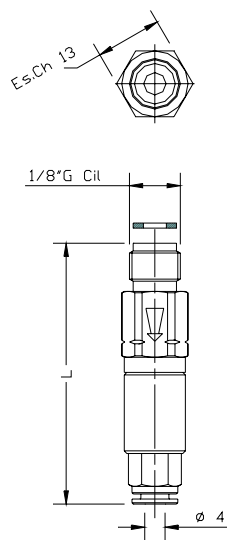
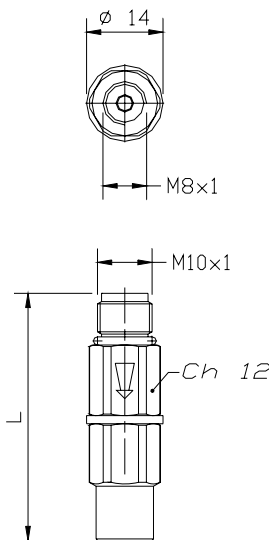

Code	L	Code	L	Code	L	Code	L
02.713.0/4	45.5 mm	02.742.0/4	51 mm	02.739.0/4	32 mm	02.737.0/4	42 mm
02.713.5/6	51.1 mm	02.742.5/6	56.6 mm	02.739.5/6	37.6 mm	02.737.5/6	47.6 mm

M10x1 (M) - 1/8" (M) Straight

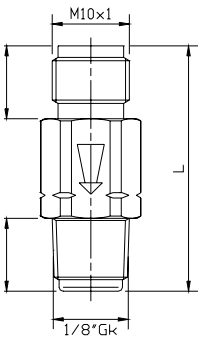
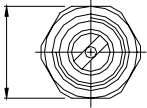

Code	Flow rate	Mark
02.711.0	15 mm ³	15
02.711.1	30 mm ³	30
02.711.2	60 mm ³	60
02.711.3	100 mm ³	100
02.711.4	160 mm ³	160
02.711.5	200 mm ³	200
02.711.6	300 mm ³	300

Code	L
02.711.0/4	45.5 mm
02.711.5/6	51.1 mm

M10x1 (M) - 1/4" (M) Straight

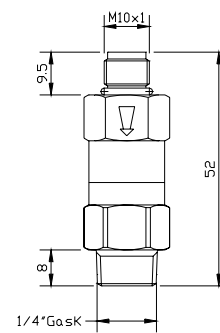
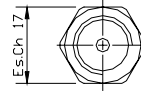

Code	Flow rate	Mark
02.602.6	500 mm ³	6
02.602.7	750 mm ³	7
02.602.8	1000 mm ³	8

Code	L
02.602.6/8	51 mm

5/16" (M) - 1/8" (M) Straight

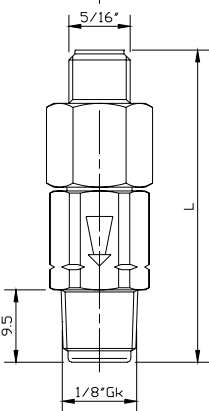
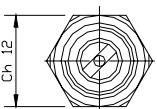

Code	Flow rate	Mark
02.736.0	15 mm ³	15
02.736.1	30 mm ³	30
02.736.2	60 mm ³	60
02.736.3	100 mm ³	100
02.736.4	160 mm ³	160
02.736.5	200 mm ³	200
02.736.6	300 mm ³	300

Code	L
02.736.0/4	41 mm
02.736.5/6	46.6 mm

PUSH IN - 1/8" (M) Straight

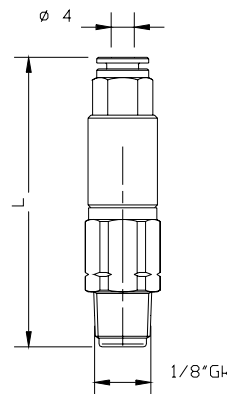

Code	Flow rate	Mark
02.712.0	15 mm ³	15
02.712.1	30 mm ³	30
02.712.2	60 mm ³	60
02.712.3	100 mm ³	100
02.712.4	160 mm ³	160
02.712.5	200 mm ³	200
02.712.6	300 mm ³	300

Code	L
02.712.0/4	46.5 mm
02.712.5/6	52.1 mm

The seals are NBR. On request, valves with Viton seals are available, add the letter "V" to the code, e.g. 02.709.0.V

09.015.0

09.016.0

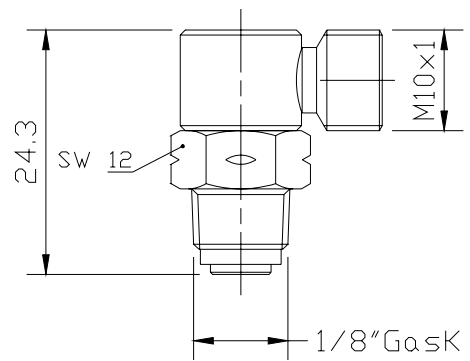
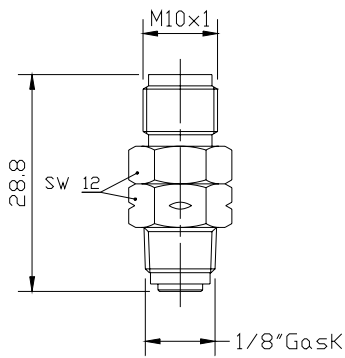

09.018.0

09.020.0

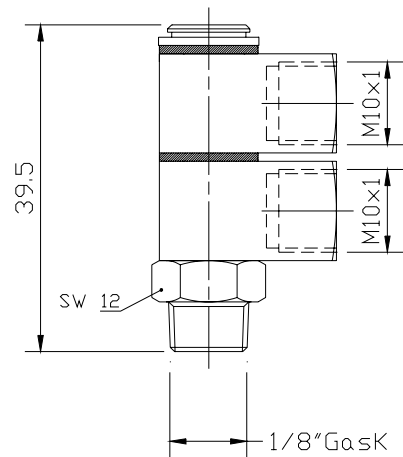
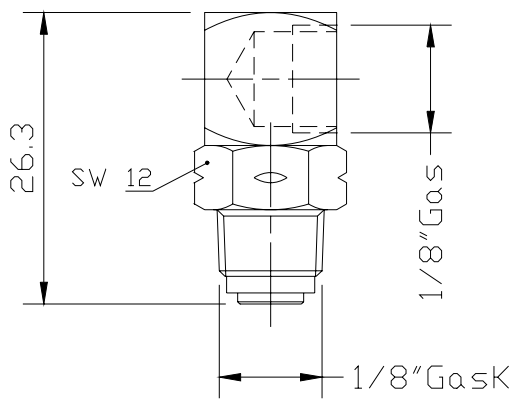
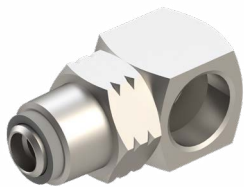

M12x1 - M10x1

One-sided



Code	Outlets	A	B
01.520.0	1	40	20
01.521.0	2	61	41
01.522.0	3	82	62
01.523.0	4	103	83
01.524.0	5	124	104
01.525.0	6	145	125
01.526.0	7	166	146
01.527.0	8	187	167
01.528.0	9	208	188
01.529.0	10	229	209

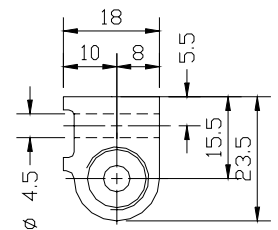
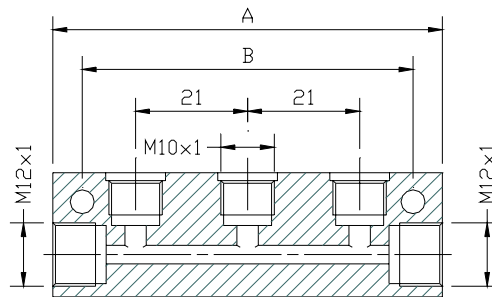

Two-sided



Code	Outlets	A	B
01.540.0	2	40	20
01.541.0	4	61	41
01.542.0	6	82	62
01.543.0	8	103	83
01.544.0	10	124	104
01.545.0	12	145	125
01.546.0	14	166	146

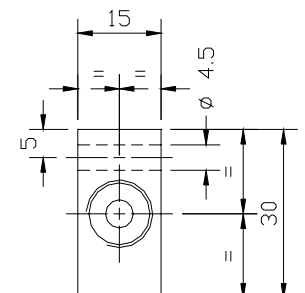
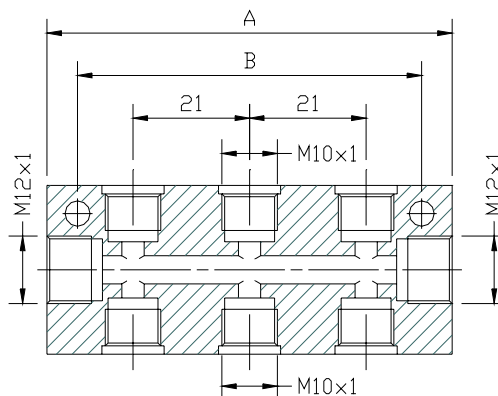

1/8" - 1/8"

One-sided



Code	Outlets	A	B
01.420.0	1	40	20
01.420.1	2	61	41
01.420.2	3	82	62
01.420.3	4	103	83
01.420.4	5	124	104
01.420.5	6	145	125
01.420.6	7	166	146
01.420.7	8	187	167
01.420.8	9	208	188
01.420.9	10	229	209

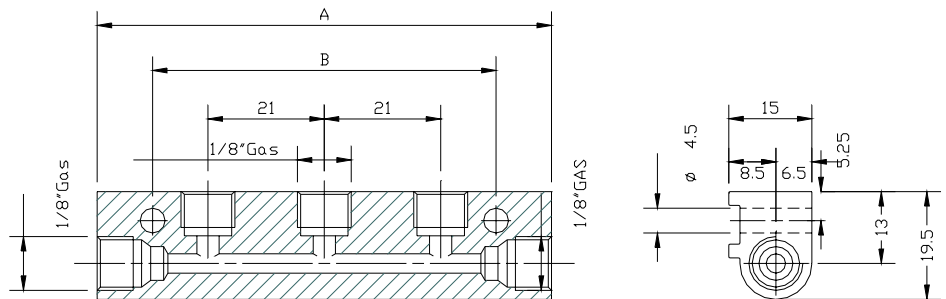

Two-sided

Code	Outlets	A	B
01.421.0	2	40	20
01.421.1	4	61	41
01.421.2	6	82	62
01.421.3	8	103	83
01.421.4	10	124	104
01.421.5	12	145	125
01.421.6	14	166	146

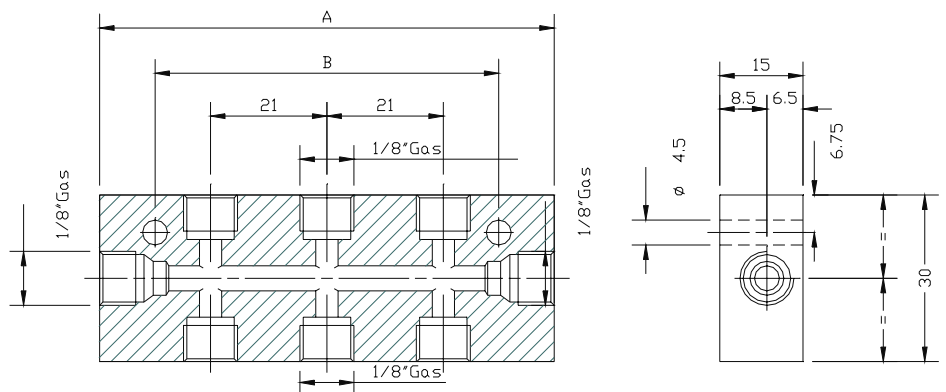

M10x1 - M10x1 2-Way

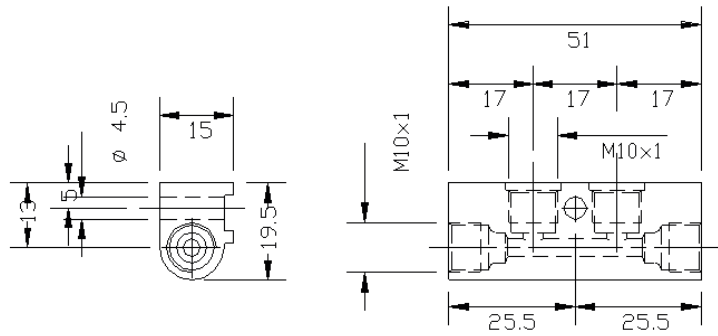

Code 01.961.0

M10x1 - M10x1 3-Way

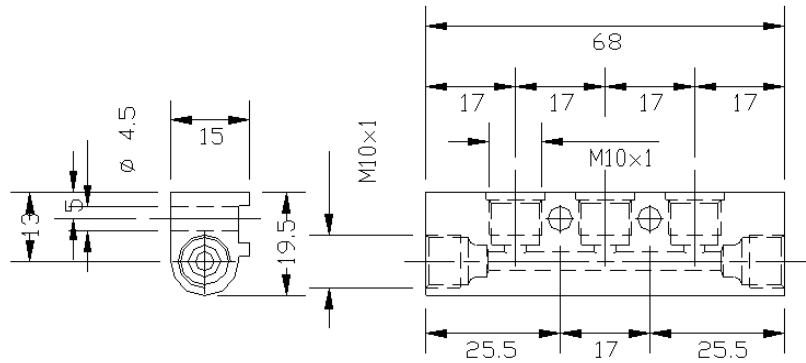

Code 01.961.1

M10x1 - M10x1 5-Way

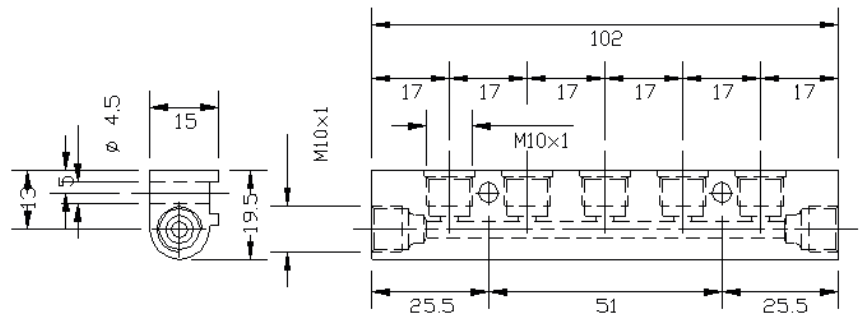

Code 01.961.2

Single piston metering valves

Single valves can be used to replace faulty valves mounted on the distributor outlets with M8x1 thread.

M8x1 - M8X1

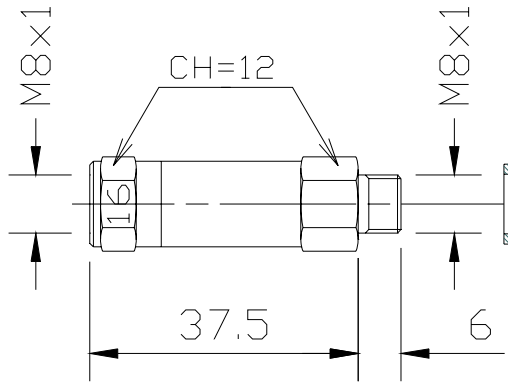

Code	Flow rate	Mark
02.610.1	30 mm ³	3
02.610.2	60 mm ³	6
02.610.3	100 mm ³	10
02.610.4	160 mm ³	16

M8x1 - M10X1

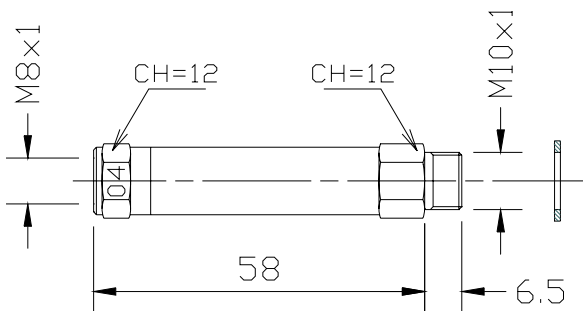

Code	Flow rate	Mark
02.611.5	30 mm ³	3
02.611.6	60 mm ³	6
02.611.7	100 mm ³	10
02.611.8	160 mm ³	16

M10x1 (M) - M10x1 (M)

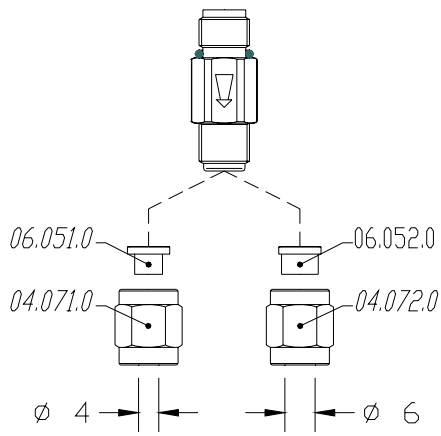

M10x1 (M) - M8x1 (F)

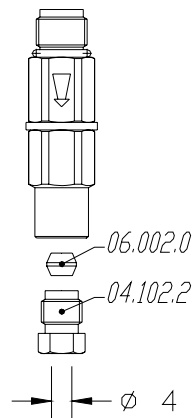

M10x1 (M) - PUSH-IN

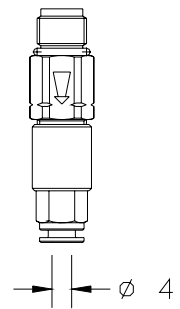

1/8" (M) - M10x1 (M)

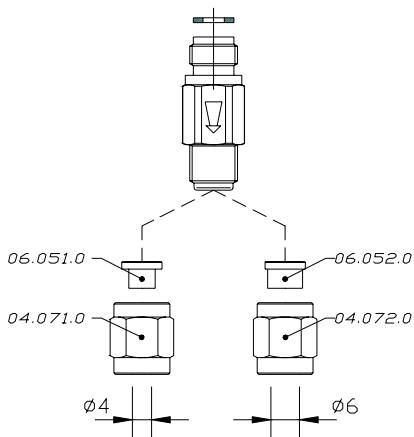

1/8" (M) - 5/16" (F)

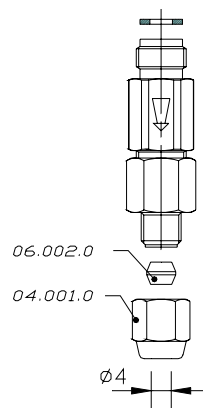

1/8" - PUSH IN

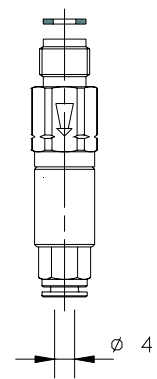

M10x1 (M) - 1/8" (M)

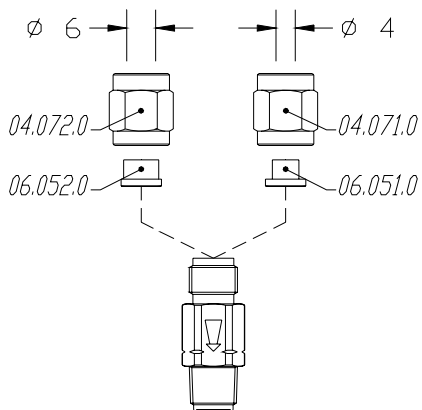

Fittings for Distributor M12x1 - M10x1

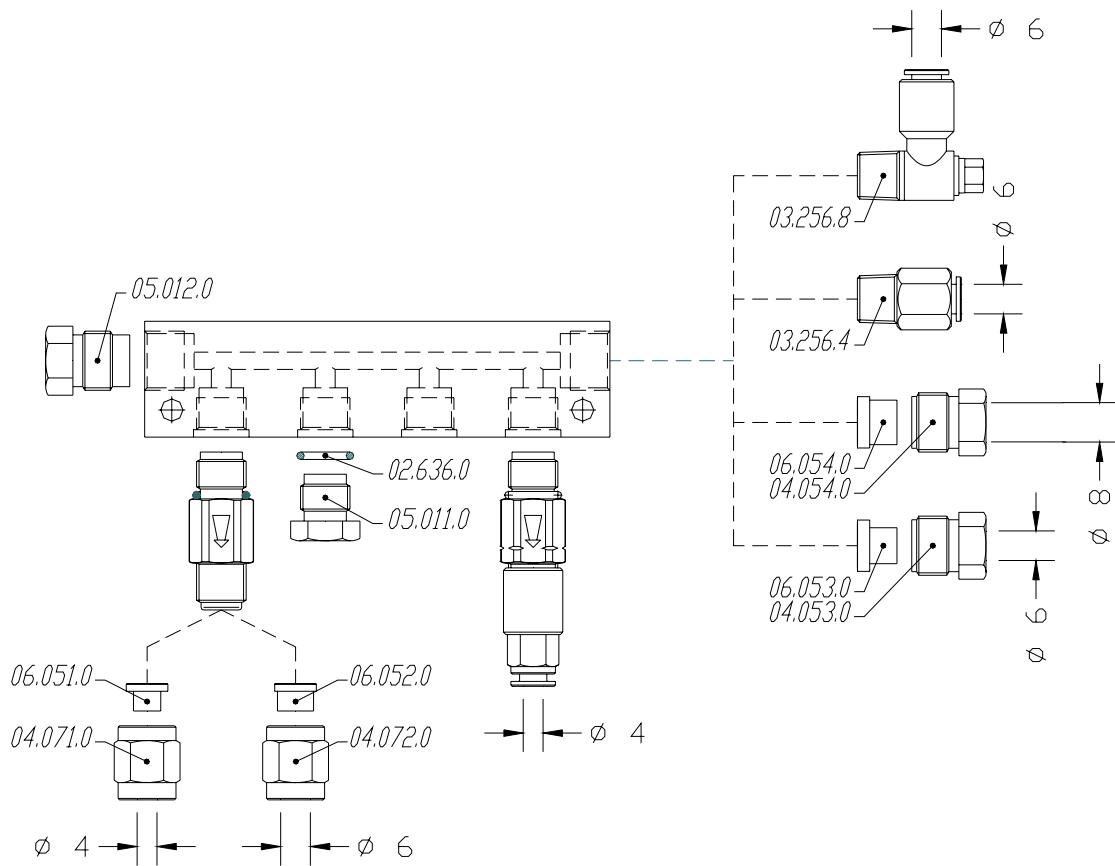

Fittings for Distributor M10x1 - M10x1

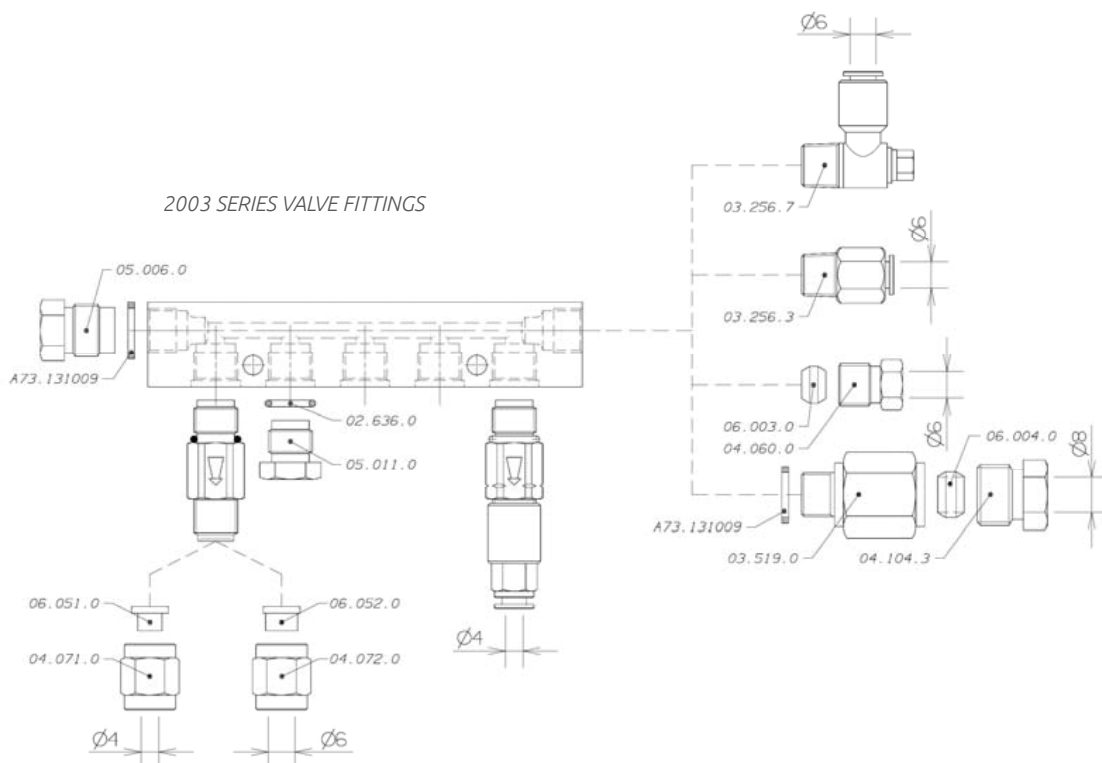

Fittings for Distributor 1/8" - 1/8"

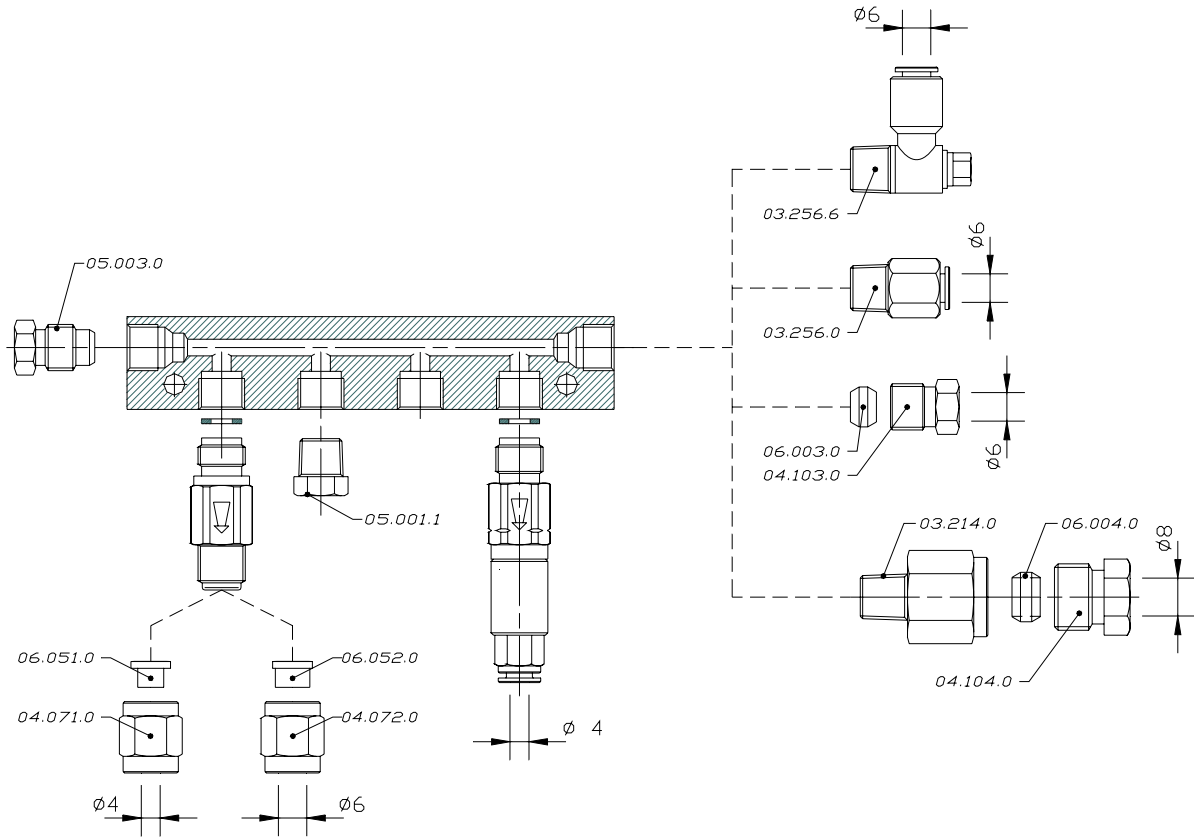

Fittings for Distributor 2-way M12x1 - 6-way M10x1

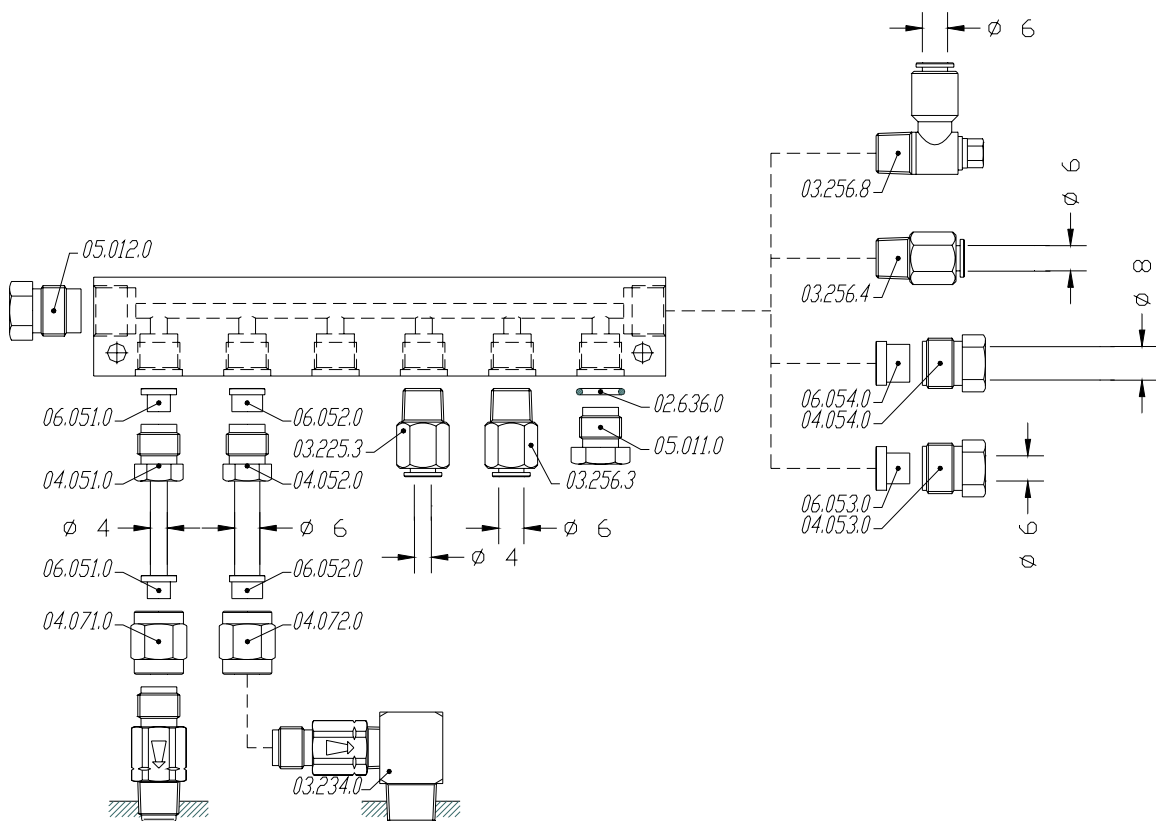

Fittings for swivel terminals

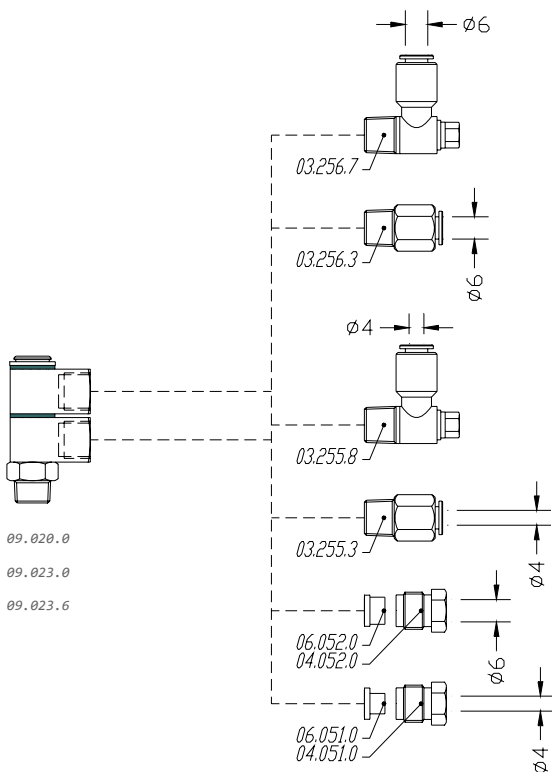
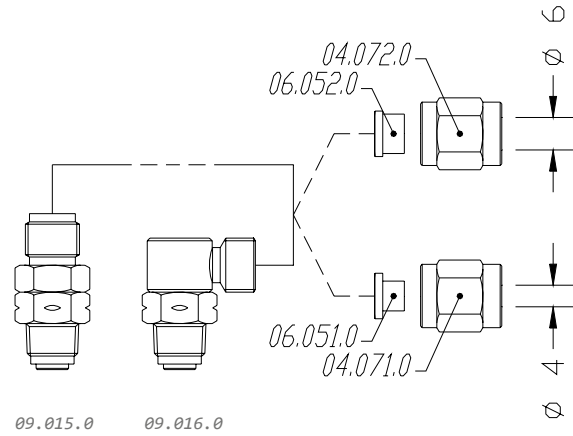
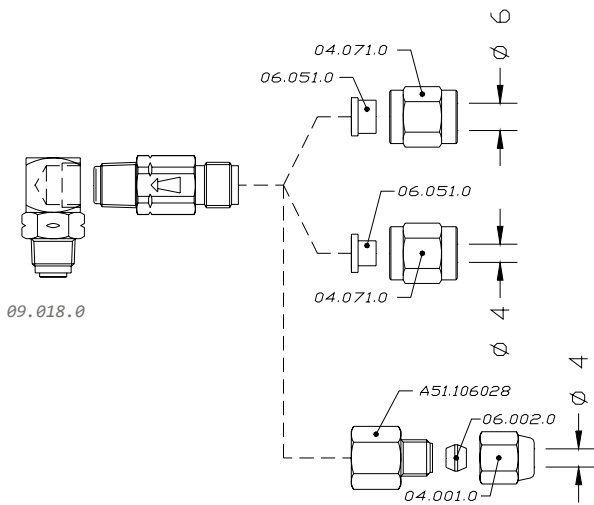

I.L.C. srl - Via Garibaldi, 149 - 20155 Gorla Minore - Italy
Phone +39 0331 601697 - Fax +39 0331 602001 - www.ilclube.com - info@ilclube.it

