

Extension and connecting tubes for control valve Griff E

The control valve Griff E with screwed on hydraulic coupler is supplied as standard product.
 The hydraulic coupler and the connecting tube with coupling nut M 16 x 1.25 is also deliverable as spare Part-No. 526-34044-5.

Connecting tubes

For all domed-head lubrication fittings acc. to DIN 3402

Example:

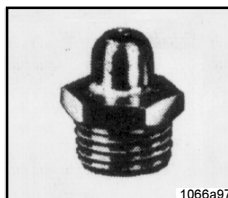
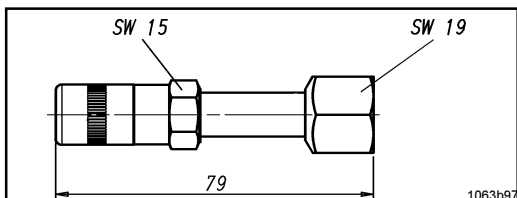

Type „A“
 AM 10 x 1
 AR 1/8“

This hydraulic coupler is suitable for all hydraulic lubrication fittings acc. to DIN 71412



Type „A“
 straight hydraulic lubrication fitting

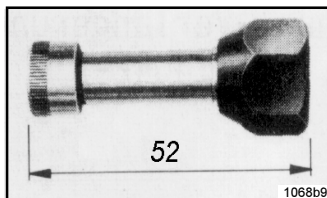

Connecting tube domed-head coupler
 No. 526-34044-7

For all flush lubrication fittings acc. to DIN 3405

Example:

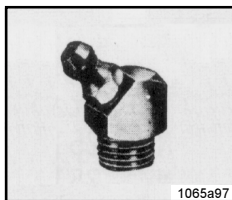

Type „B“
 45° angle hydraulic lubrication fitting

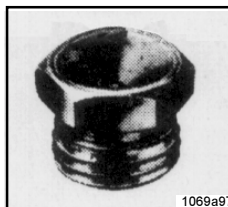

Type „A“
 AM 10 x 1
 AM 8 x 1
 AM 6

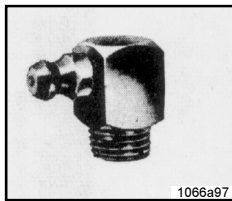

Type „C“
 90° angle hydraulic lubrication fitting

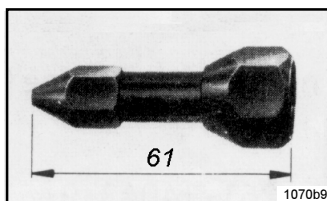

Connecting tube with flush coupler
 No. 526-34044-8

If other lubrication fittings are available, the connecting tube with the hydraulic coupler is to be unscrewed and replaced by the following connecting tubes with coupling M 16 x 1.25.

Extension and connecting tubes for control valve Griff E

For all button head lubrication fitting acc. to DIN 3404

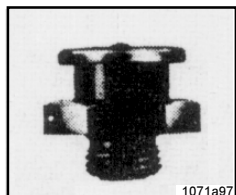

Form A
 AM 10 x 1, AR 1/4" Lubrication fitting DIA 16, with over flats 17
 AM 16 x 1,5, AR 3/8" Lubrication fitting DIA 22, with over flats 22

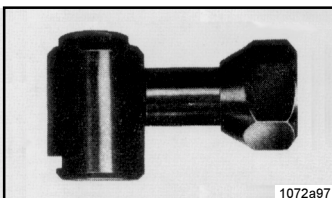

Connecting tube with push coupler
 Lubrication fitting DIA 16
 Lubrication fitting DIA 22

Part-No.
 526-34044-3
 526-34044-4

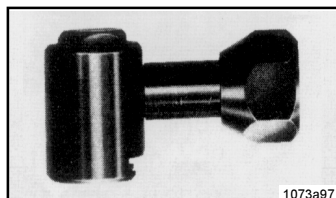

Connecting tube with pull coupler
 Lubrication fitting DIA 16
 Lubrication fitting DIA 22

Part-No.
 526-34044-1
 526-34044-2

Extension tubes

For lubrication fittings which cannot be reached by means of the connecting tubes, the following extension tubes, each having an inch thread of M 16 x 1.25 and a coupling nut M 16 x 1.25, can be supplied:

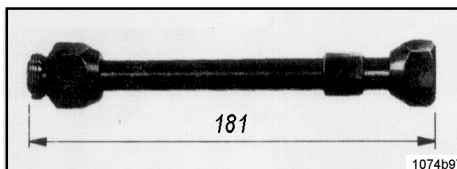

Straight extension tube Part-No.
 526-34044-9

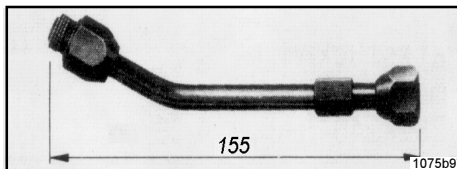

Angle extension tube Part-No.
 526-32317-1

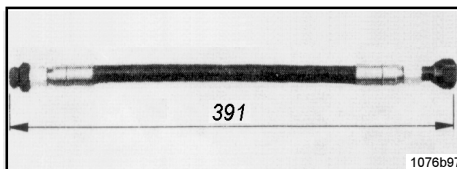

Extension hose Part-No.
 526-34044-6

For domed-head lubrication fittings and hydraulic lubrication fittings that are difficult to reach, an adapter can be supplied:

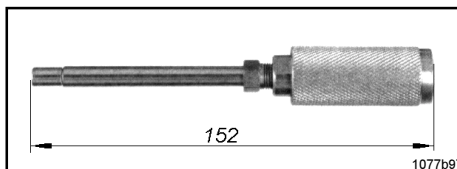

Part-No.
 005855

At the end of a thin extension tube the adapter is fitted with a coupler, the adapter is connected with the hydraulic coupler by means of a locking sleeve.

LINCOLN Griff E

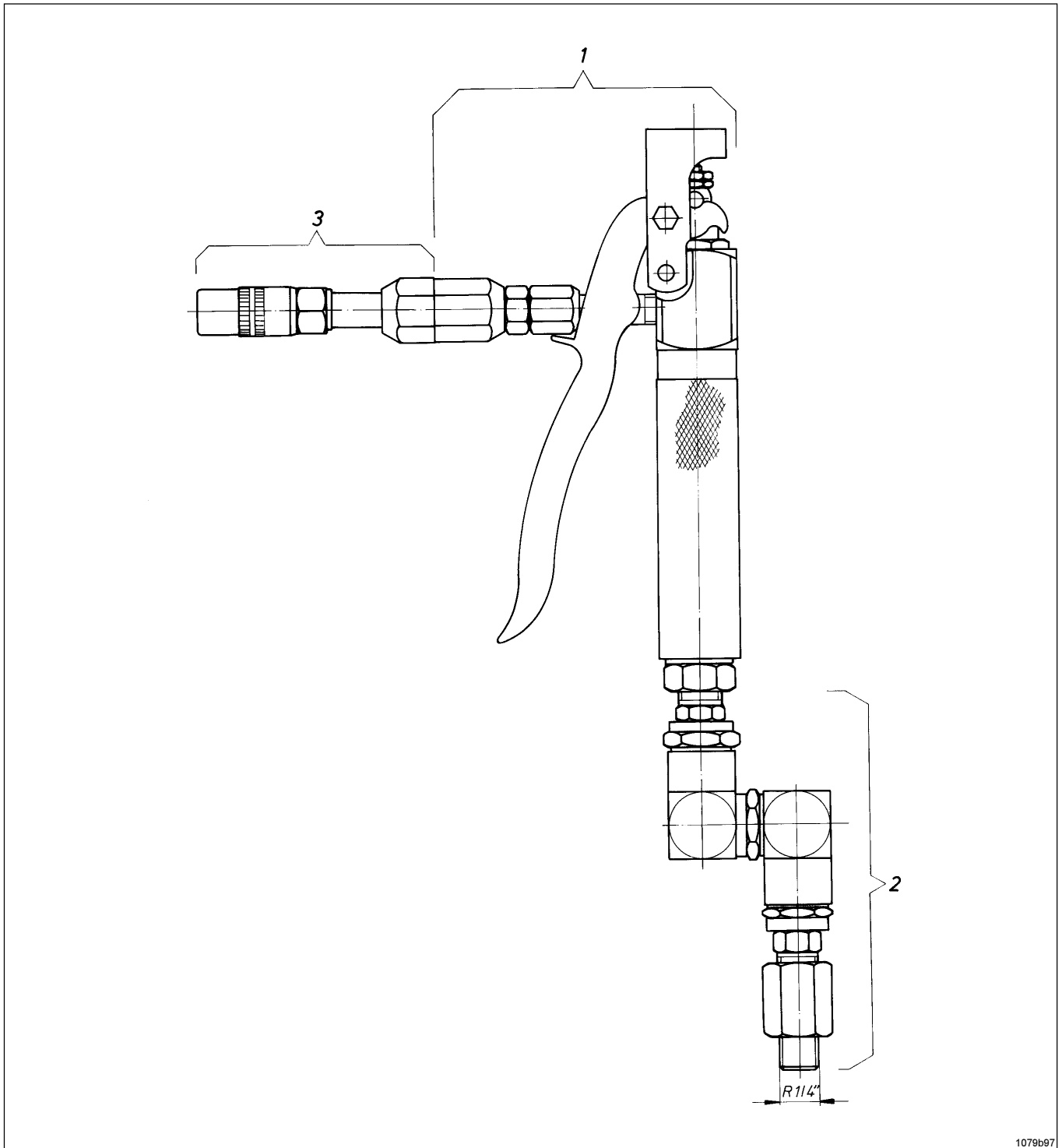

1079b97

Item	Designation	Part-No.
------	-------------	----------

1	control valve	626-27172-1
2	universal swivel with hose connection	626-27204-1
3	hydraulic coupler with connecting tube	526-34044-5

Subject to modifications

Universal swivel with hose connection

Part-No. 626-27204-1

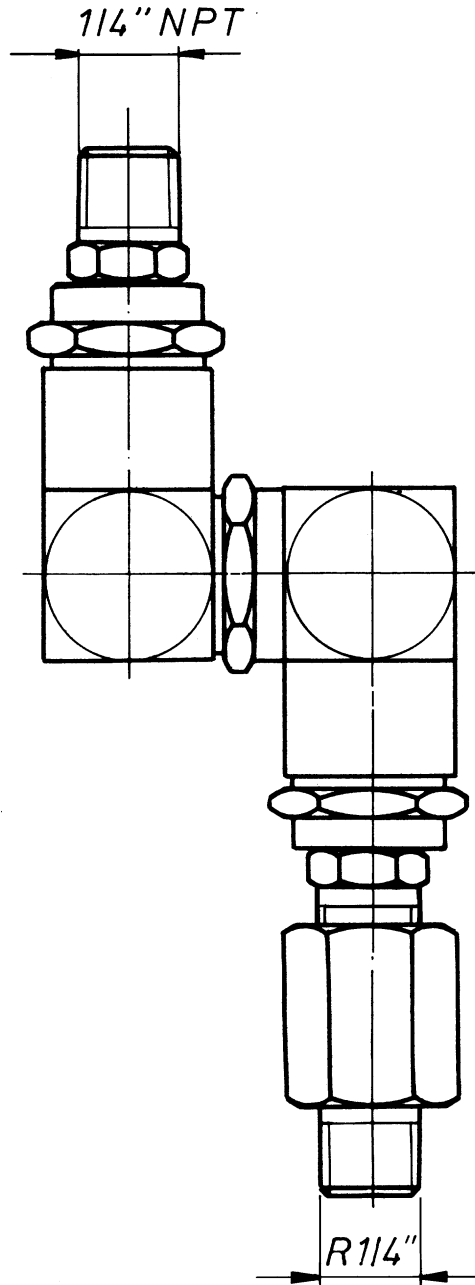

1078a97

Grease gun for use with Lincoln Control Valve Griff E

Part-No. 626-27172-1

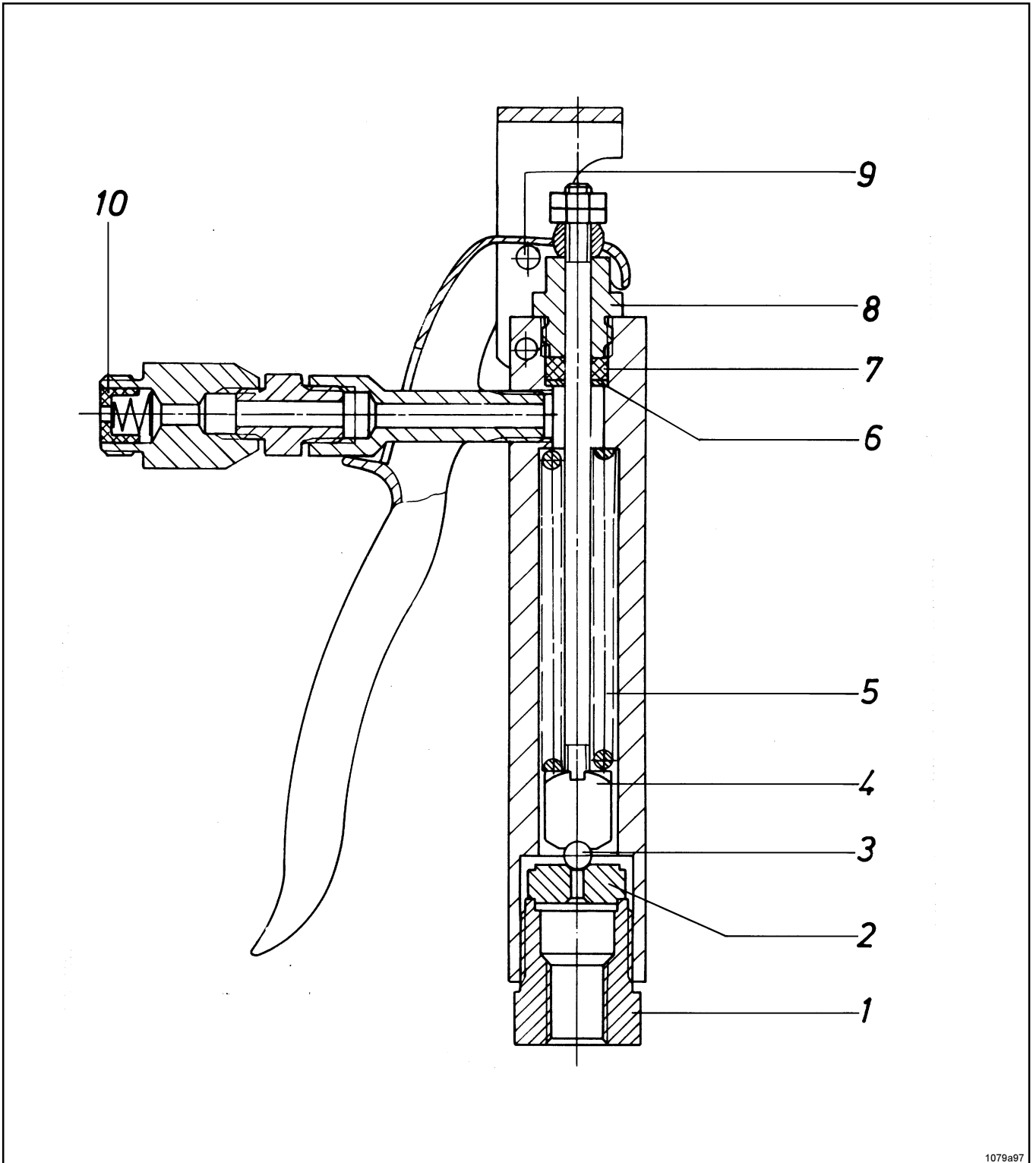

1079a97

Subject to modifications

Grease gun for use with Lincoln Control Valve Griff E

Part-No. 626-27172-1

Item	Designation	Part-No.
1	coupling nut	012829
2	check seat	011364
3	steel ball	066255
4	ball retainer	011363
5	compression spring	055029
6	washer	048218
7	packing	035007
8	packing gland	012826
9	toggle pivot screw	011837
	hexagon nut	051043
10	axial cup seal D80 with spring	251-14045-5