

CENTRO-MATIC SYSTEM - OWNER/OPERATOR MANUAL

It is the responsibility of the Owner/Operator to properly use and maintain this equipment.

The Instructions and Warnings contained in this manual shall be read and understood by the Owner/Operator prior to operating this equipment.

It is the responsibility of the Owner/Operator to maintain the legibility of all Warning and Instruction labels.

The Owner/Operator shall retain this manual for future reference to important Warnings, Operating and Maintenance Instructions.

CONTENTS	PAGE
Specifications	1
Description	1
Liquid Crystal Display	2
Programming Mode	2
Run Mode	5
Alarm Messages	5
Field Connections	6
Service Parts	7

SPECIFICATIONS

Input Voltage	120 VAC 50/60 Hz 230 VAC 50/60 Hz 24 VDC
Current Consumption	85 MA at 120 VAC (less load) 45 MA at 230 VAC (less load) 250 MA at 24 VDC (less load)
External Pump Load	360VA Pilot Duty Rating at 120/230 VAC
External Alarm Load	5 amps at 24 VDC
Ampacity for Switches connected to Terminal Strip B....	8 MA at 15 VDC
Enclosure	Nema 12 enclosure
Ambient Temperature Range	10° F to 130° F (LCD limited)
Net Weight	10 lbs.
Off Time	1 minute minimum 9,900 minutes maximum
Off Counts	1 count minimum 99,000 counts maximum
Alarm Time	1 minute minimum 99 minutes maximum
Timing Accuracy01% (crystal controlled)
Count Rate	30 counts/sec. at 50% duty cycle

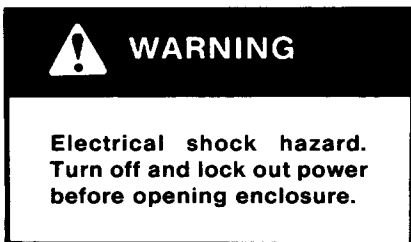

DESCRIPTION

When programmed as a Centro-Matic Controller, Model 84530 will have complete control of your lubrication system. The system status is continuously updated and displayed on a two line liquid crystal display.

Due to the numerous options available, the customer can field program the controller to match the system requirements. Programming is easily accomplished by following a user friendly menu displayed on the LCD and pressing the active buttons beneath the display. An internal jumper pin provides security against unauthorized programming. All programmed parameters are automatically stored in a nonvolatile memory. A Review Screen can be easily activated to display what has been programmed. Programmed values can be changed whenever necessary.

There are three lights on the enclosure door to indicate the status of the system.

Green - Power On **Amber** - Pump On **Red** - Alarm

If an alarm occurs, the cause of the alarm will appear on the LCD. Turning off power to the controller when in alarm will always initiate a lube cycle when turned back on.

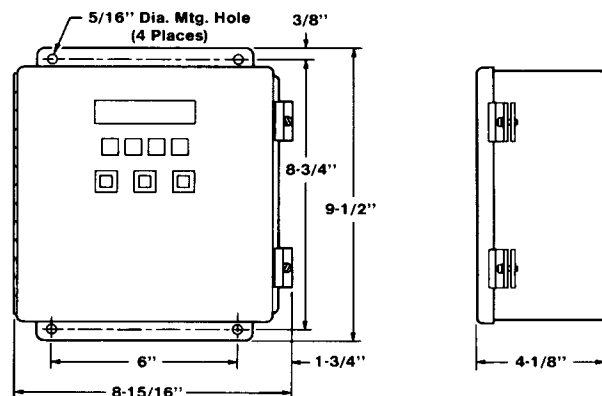

DIMENSIONS

The LCD is capable of displaying the following messages:

- Time or Counts left until next lube cycle.
- Amount of time system has been lubricating.
- Will indicate if in a Standby Mode.
- Controller Reset Failure Alarm
- Low Level Alarm
- Vent Pressure Switch Alarm.

LIQUID CRYSTAL DISPLAY

The LCD has a bottom to top viewing angle. It is recommended that the controller be mounted slightly above eye level for optimum viewing.

The first line of the LCD is an instruction line or a message. The second line can have up to four commands, each corresponding to the button beneath it. Pressing the corresponding button will invoke that command.

The following example shows the MAIN MENU.

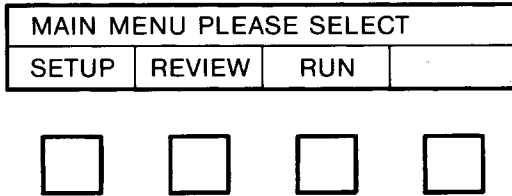

SETUP - Pressing the button beneath SETUP will display the SETUP MENU

REVIEW - Pressing the button beneath REVIEW will display the REVIEW SCREENS.

RUN - Pressing the button beneath RUN will cause the controller to function as it was programmed in the SETUP MENU.

PROGRAMMING MODE

To program a new controller, use the following example as a guide to match the controller to your system requirements. The internal jumper pin will be in the Program position for a new controller.

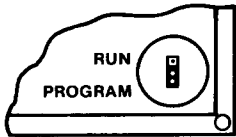

JUMPER IN
"PROGRAM" POSITION

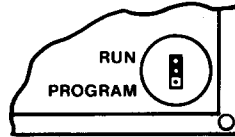

JUMPER IN
"RUN" POSITION

If a controller already in use needs to be reprogrammed, the internal jumper pin must be moved from the Run position to the Program position. **WARNING: Turn power off before opening enclosure door to move jumper pin.**

If no buttons are pressed within a 30 second period, the display will automatically change to "SET JUMPER TO RUN". Pressing the button under "<" will display the MAIN MENU.

EXAMPLE:

The following instructions will illustrate how to program a Centro-Matic System with these sample parameters.

STEP		
4	TIMER OR COUNTER.....	TIMER
5	OFF TIME.....	30 min.
6	ALARM TIME.....	5 min.
7	ALARM LOCKOUT.....	YES
8	ALARM INTERLOCK LOW LEVEL.....	NO
9	ALARM RELAY ENERGIZED.....	NO
10	PRELUBE.....	YES
11	3 HOUR MEMORY.....	YES
12	MANUAL LUBE ON DOOR.....	YES
13	MANUAL LUBE WHILE IN ALARM.....	YES
14	IS STANDBY MODE USED.....	NO
15	IS VENT PRESSURE SWITCH USED...	NO

1) Reminder that if the Run Mode is desired the jumper must be set to Run.

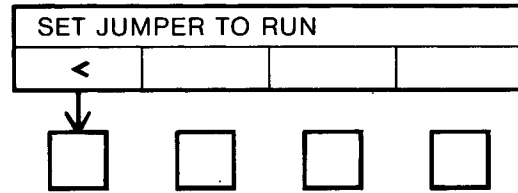

Press button under "<".

2) Main Menu options.

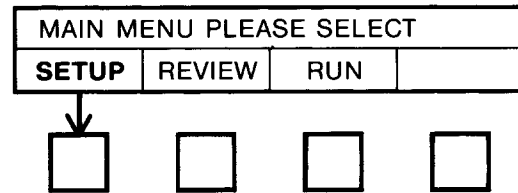

SETUP - All programming options are available in the Setup Menu.

REVIEW - Can review all system parameters that have been programmed in the Setup Menu.

RUN - Controller will function as it was programmed in the Setup Menu.

Press button under "SETUP".

3) Setup Menu options.

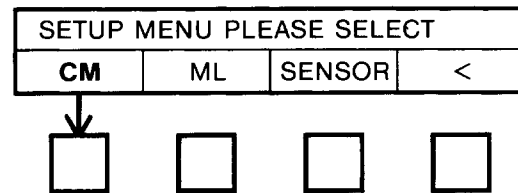

CM - Programming options for a Centro-Matic Controller.

ML - Programming options for a Modular Lube Controller (see ML Manual).

SENSOR - Programming options for a Sensor Controller (see Sensor Manuals).

< - Will return you to the previous screen.

Press button under "CM".

4) Choice of Timer or Counter.

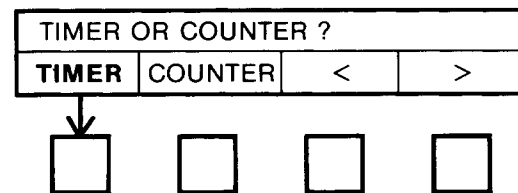

TIMER - Time will be the measurement between lube cycles.

COUNTER - Counts will be the measurement between lube cycles.

< - Previous screen.

> - Next screen.

Press button under "TIMER".

5) Amount of time between lube cycles.

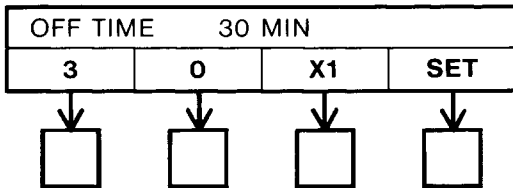

Pressing either of the first two buttons will increment number above it by one.

First Two Buttons - Determines the first two digits of the Off Time.

Third Button - A multiplier for the first two digits.

X1 Multiplies first two digits by 1. Range: 1 to 99 min.

X10 Multiplies first two digits by 10. Range: 10 to 990 min.

X100 Multiplies first two digits by 100. Range: 100 to 9900 min.

SET - Stores value displayed on screen.

Press first button until a 3 appears.

Press second button until a 0 appears.

Press third button until an X1 appears.

Press button under "SET" to input 30 min.

6) Amount of pumping time system has before an alarm will occur.

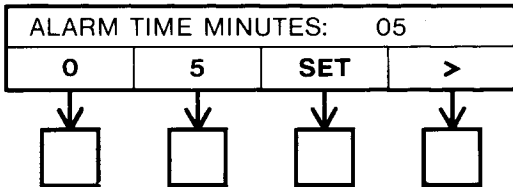

Pressing either of the first two buttons will increment number above it by one.

First Two Buttons - Determines alarm time.
Range: 1 to 99 Min.

SET - Stores value displayed on screen.

> - Next screen.

Press first button until a 0 appears.

Press second button until a 5 appears.

Press button under "SET" to input 5 min.

Press button under ">"

7) Choice of locking system out from lubricating again during an alarm condition.

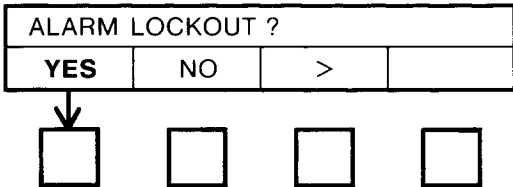

YES - If an alarm condition occurs the system will not lubricate again and the following will happen:

- Alarm message will appear.
- Alarm relay contact will change over.
- Red light on enclosure door will turn on.

NO - If an alarm condition occurs the system will try to lubricate again and the following will happen:

- An alarm message will alternate with the lube screen.
- Alarm relay contact will change over.
- Red light on enclosure door will turn on.

If a successful lube event occurs the alarm will be cleared.

> - Next screen.

Press button under "YES".

8) Option for Low Level Alarm.

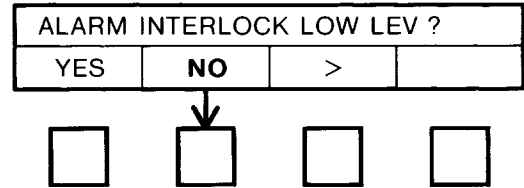

YES - Will follow the program option set in Step 7.

NO - System continues to operate with the following conditions:

- An alarm message will alternate with the lube screen.
- Alarm relay contact will not change.
- Red light on enclosure door will turn on.

> - Next Screen.

Press button under "NO".

9) Option for Alarm Relay, to be used with external device.

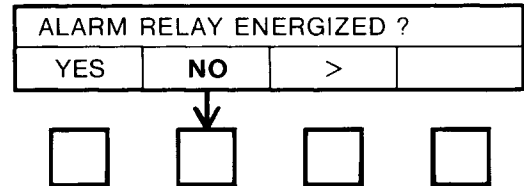

YES - Alarm relay contact will open if a fault occurs.

NO - Alarm relay contact will close if a fault occurs.

> - Next screen.

Press button under "NO".

10) Option of using Prelube.

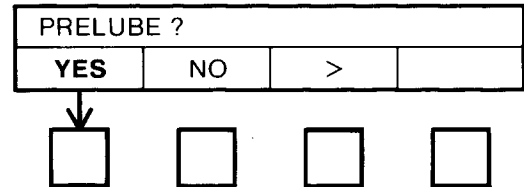

YES - When power is applied to controller a lube cycle will occur. If the 3 Hour Memory in Step 11 is set to "YES" and power has been off for less than 3 hours, a prelube will not occur.

NO - Prelube will not take place.

> - Next screen.

Press button under "YES".

11) Choice of using Three Hour Memory.

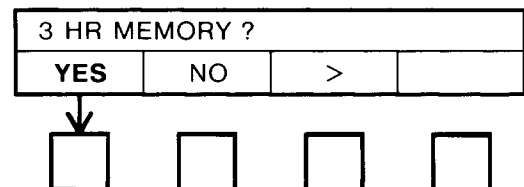

YES - If power has been turned off less than 3 hours and then is reapplied, lube cycle will continue from point of interruption. If power has been turned off longer than 3 hours and then is reapplied, the controller will begin as programmed in Step 10.

NO - Memory option turned off.

> - Next screen.

Press button under "YES".

12) Choice of manually lubing from enclosure door.

ACTIVATE MAN LUBE DOOR ?			
YES	NO	>	

↓

YES - Can manually lube system from door.
NO - Cannot manually lube system from door.
 > - Next screen.

Press button under "YES".

13) Choice of manually lubing from enclosure door during alarm.

MANUAL LUBE IN ALARM ?			
YES	NO	>	

↓

YES - Can manually lube system from door during an alarm condition.
NO - Cannot manually lube system from door during alarm.
 > - Next screen.

Press button under "YES".

14) Option of using Standby Mode, to temporarily suspend controller operation using an external switch.

IS STANDBY MODE USED ?			
YES	NO	>	

↓

YES - A switch closure at terminal strip B terminals 13 and 14 will suspend operation of controller without removing power.
NO - Standby Mode not used.
 > - Next screen.

Press button under "NO".

15) Option of using Vent Pressure Switch.

IS VENT PRESS SW USED ?			
YES	NO	>	

↓

YES - The Vent Pressure Switch is located in the pressure line and will indicate if the supply line has not vented low enough to reset the injectors. Vent Pressure Switch is ignored when Manual Lube Switch is used.
NO - Vent Pressure Switch is not used.
 > - Next screen.

Press button under "NO".

16) Option for Vent Pressure Switch Alarm.

ALARM INTERLOCK VENT SW ?			
YES	NO	>	

This display appears if "YES" option is selected in Step 15.
YES - Will follow the program option set in Step 7.
NO - System continues to operate with the following conditions:

An alarm message will alternate with the lube screen.
 Alarm relay contact will not change.
 Red light on enclosure door will turn on.

> - Next screen.

This display does not appear in our example because a Vent Pressure Switch is not used (see Step 15).

17) When programming is complete, set internal jumper pin to the Run position. **WARNING: Turn power off before opening enclosure door to move jumper pin.**

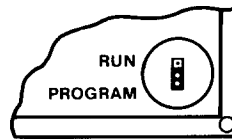

JUMPER IN "PROGRAM" POSITION

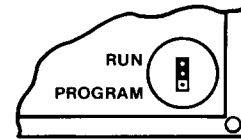

JUMPER IN "RUN" POSITION

RUN MODE

To access the Run Mode the internal jumper must be in the Run position. **WARNING: Turn power off before opening enclosure door to move jumper pin.**

If no pushbuttons are pressed within 30 seconds, while in the Main Menu options, the controller will enter the RUN MODE.

The following screens can appear when in the Run Mode.

Main Menu Options.

MAIN MENU PLEASE SELECT			
SETUP	REVIEW	RUN	



SETUP - All programming options are available in the Setup Menu.

REVIEW - Can review all system parameters that have been programmed in the Setup Menu.

RUN - Controller will function as it was programmed in the Setup Menu.

Indicates the amount of time or counts remaining before the next lube cycle.

NEXT LUBE IN:		30 MIN	
MANUAL			MENU



MANUAL - Pressing the corresponding button will initiate a lube cycle.

MENU - Pressing the corresponding button will cause the Main Menu to appear.

Indicates the amount of time that the system has been lubing.

NOW LUBRICATING		1 MIN	



Indicates that the controller is in a Standby Mode due to the contact closure at terminals 13 and 14 on terminal B.

STANDBY MODE			



ALARM MESSAGES:

The following alarm messages can appear if an alarm condition occurs.

Indicates that the system reservoir needs to be replenished.

LOW LEVEL ALARM			
MANUAL		NEXT	



MANUAL - Will appear if programmed. Pressing the corresponding button will initiate a lube cycle.

NEXT - Indicates that there is more than one alarm message. Pressing the corresponding button will display the next alarm message.

Indicates that the system pressure switch has failed to activate within the alarm time setting that was programmed in setup.

CONTROLLER RESET FAILURE			
MANUAL		NEXT	



MANUAL - Will appear if programmed. Pressing the corresponding button will initiate a lube cycle.

NEXT - Indicates that there is more than one alarm message. Pressing the corresponding button will display the next alarm message.

The supply line failed to vent below the setting of the vent pressure switch, therefore the injectors did not recharge.

VENT PRESSURE SW ALARM			
MANUAL		NEXT	



MANUAL - Will appear if programmed. Pressing the corresponding button will initiate a lube cycle.

NEXT - Indicates that there is more than one alarm message. Pressing the corresponding button will display the next alarm message.

FIELD CONNECTIONS (Refer To Figure 1)

TERMINAL STRIP A - HIGH VOLTAGE

Incoming Power Source - Terminals 1 & 2.

Connect the black wire to Terminal 1.
Terminals 1 and 7 are connected together internally on Terminal Strip A.

Connect the neutral or white wire to Terminal 2.
Terminals 2, 9 and 12 are connected together internally.

120 VAC 50/60 Hz - **Must set power switch to 120 VAC.**
230 VAC 50/60 Hz - **Must set power switch to 230 VAC.**

External Pump Load - Terminals 8 & 9.

360VA Pilot Duty Rating at 120/230 VAC,
5 amps at 24 VDC.

External Alarm Load - Can be used two ways.

1. Terminals 10 & 11 - N.O. Contact.
2. Using the Controller Line Voltage at Terminals 1 & 2 (see Figure 2).
 - a) Jumper wire between Terminals 7 & 10.
 - b) Connect alarm load to Terminals 11 & 12.

360VA Pilot Duty Rating at 120/230 VAC,
5 amps at 24 VDC.

TERMINAL STRIP B - LOW VOLTAGE

Low Level Switch - N.O. Switch, Terminals 2 & 3.
Switch Ampacity 8 MA at 15 VDC.

Count Switch - N.O. or N.C. Switch, Terminals 6 & 7.
Switch Ampacity 8 MA at 15 VDC.

Pressure Switch - N.O. Switch, Terminals 8 & 9.
Switch Ampacity 8 MA at 15 VDC.

Pressure Switch must be used.

Remote Manual Lube - N.O. Switch, Terminals 11 & 12.
Switch Ampacity 8 MA at 15 VDC.

Standby Switch - N.O. Switch, Terminals 13 & 14.
Switch Ampacity 8 MA at 15 VDC.

Vent Switch - N.O. Switch, Terminals 17 & 18.
Switch Ampacity 8 MA at 15 VDC.

24 VDC Power - Controller can operate from 24 VDC instead of 120/230 VAC (see Figure 3).

1. **Cut 24 VDC pin on power supply board.**
2. Power In: Connect Battery Positive Voltage at Terminal 23.
Connect Battery Negative Voltage at Terminal 24.
3. Power for Load & Alarm relay contacts:
Connect Battery Positive Voltage at **Terminal 1 on Terminal Strip A.**
Connect Battery Negative Voltage at **Terminal 2 on Terminal Strip A.**

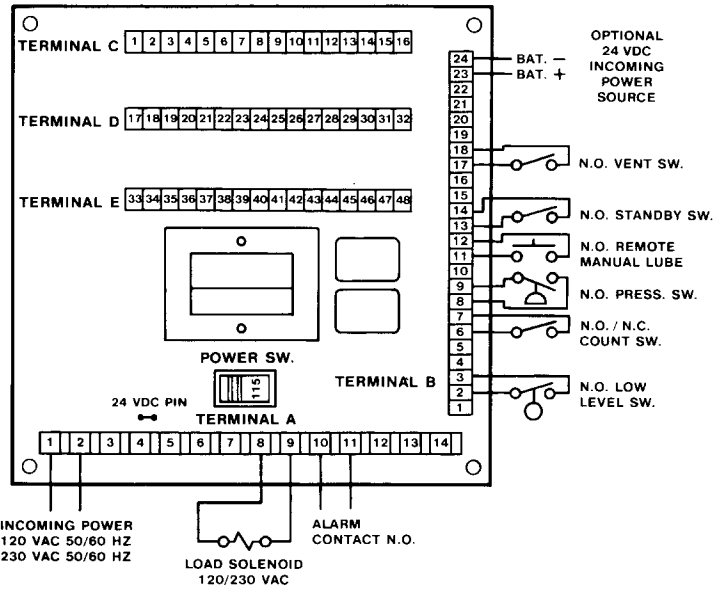

FIELD CONNECTIONS

Figure 1

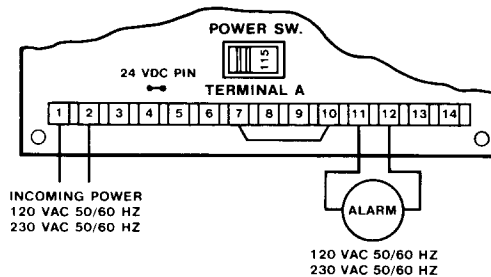

CONTROLLER LINE VOLTAGE FOR ALARM LOAD

Figure 2

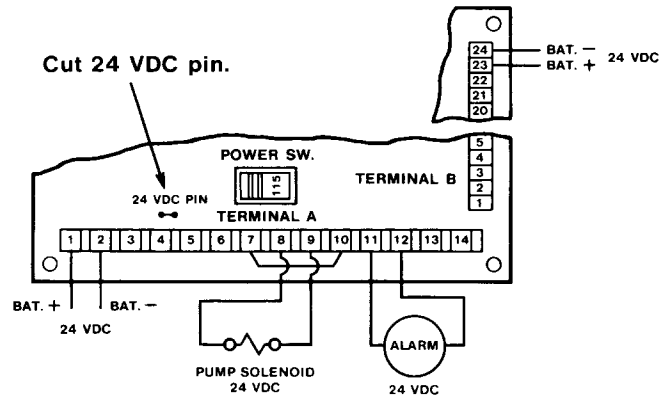

24 VDC CONNECTIONS

Figure 3

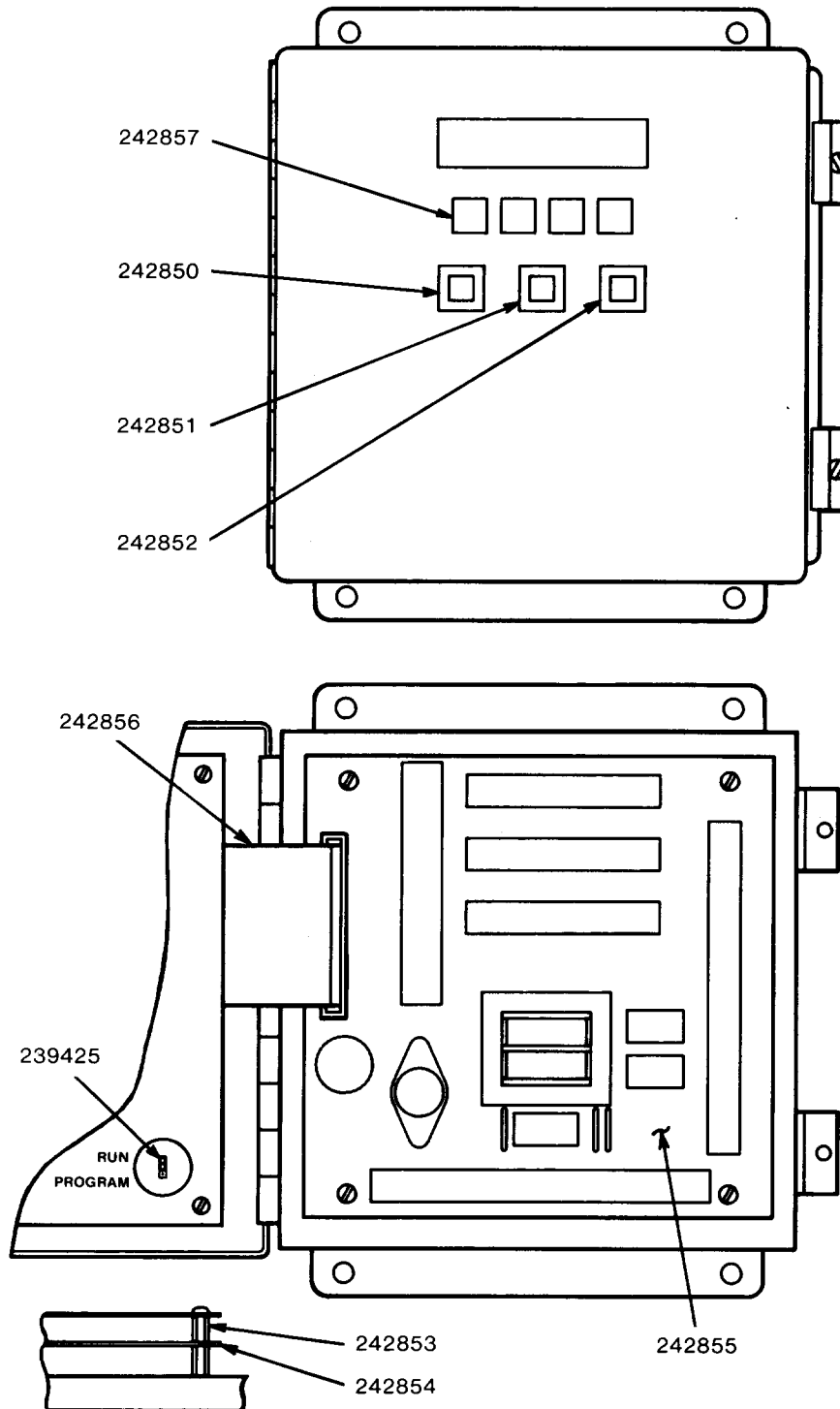

SERVICE PARTS

Part	Qty.	Description
239425	1	Jumper Shunt (strip of ten)
242850	1	Green L.E.D., Green Lens & Chrome Bezel
242851	1	Amber L.E.D., Amber Lens & Chrome Bezel
242852	1	Red L.E.D., Red Lens & Chrome Bezel
242853	4	Standoff & Screw
242854	1	Processor Board Assembly
242855	1	Power Supply Board Assembly
242856	1	Ribbon Cable Assembly
242857	1	Seal for Switches